

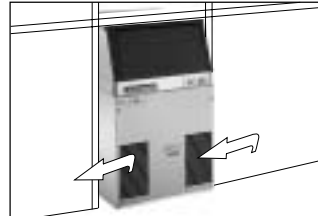

Scotsman®

AC 85

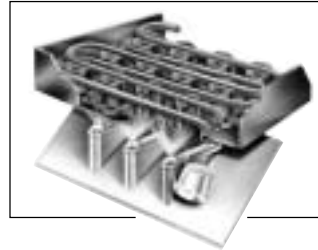

AVAILABLE AS OPTIONAL

- AC 25
- AC 45
- AC 55
- AC 85**
- AC 105
- AC 125
- AC 175
- AC 225

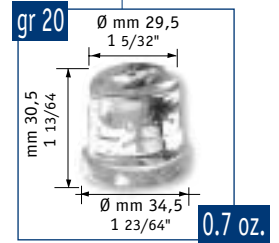

AC M 85

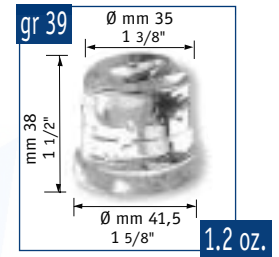

AC L 85

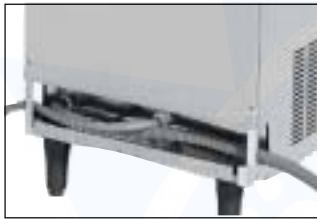

SS AISI 304

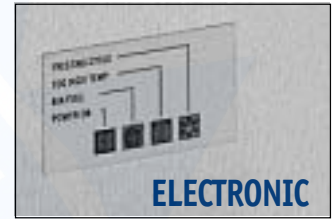

ELECTRONIC

Automatic
Gourmet-Cube
Ice Machine

Machine
Automatique
à Glaçons
Gourmet

Automatischer
Gourmetkegel-
eisbereiter

Màquina
Automàtica
Fabricadora
de Cubitos
Gourmet

Produttore
Automatico
di Ghiaccio
a Cubetti
Gourmet

Model	Temperature Range	10°: 10°C		21°: 15°C		Power	Dimensions (mm)	Dimensions (inches)	Height (mm)	Height (inches)	Ice Cube Size					
		[kg]	(lbs)N°	[kg]	(lbs)N°							[kg]	(lbs)N°	[v/Hz/ph]	[WxDxH mm]	[WxDxH inches]
AC M 85 AS	+	39	86	1950	36	79	1800	14	31	700	230/50/1	457x522x790	18"x20"x31"	H=790+120	31"+4"	R 134 a
AC M 85 WS	-	40	88	2000	37	82	1850	14	31	700	230/50/1	457x522x790	18"x20"x31"	H=790+120	31"+4"	R 134 a
AC L 85 AS	+	37	82	949	34	75	872	14	31	400	230/50/1	457x522x790	18"x20"x31"	H=790+120	31"+4"	R 134 a
AC L 85 WS	-	38	84	974	35	77	897	14	31	400	230/50/1	457x522x790	18"x20"x31"	H=790+120	31"+4"	R 134 a

*Estimate number of medium/large size gourmet cubes.
Standard legs 120 mm high included.
Leg extension 60 mm high available upon request (code no. KITLEGSEXT000).

www.scotsman-ice.com
www.scotsman-ice.it

2

Years Warranty
Ans de Garantie
Jahre Garantie
Años de Garantía
Anni di Garanzia

Subject to certain limitations and exclusions
Assujettie aux limites et exclusions prescrites
Abhängig von Bestimmten Einschränkungen und Ausnahmen
Sujeta a algunas limitaciones y exclusiones
Soggetta ad alcune limitazioni ed esclusioni



This product qualifies for the following listings:



Selçte EÖVlç
CE AÜçelçç AİAF
FGGEJAOVlç
Q } KEI JAEÄ I AFEÄ EÄGG
QæKEI JAEÄ I AFEÄ EÄGF
T ææKæ } O | ææç EÄVlç EÄ
Qæç | ^dæ , E ææç EÄVlç EÄ {

AC 85

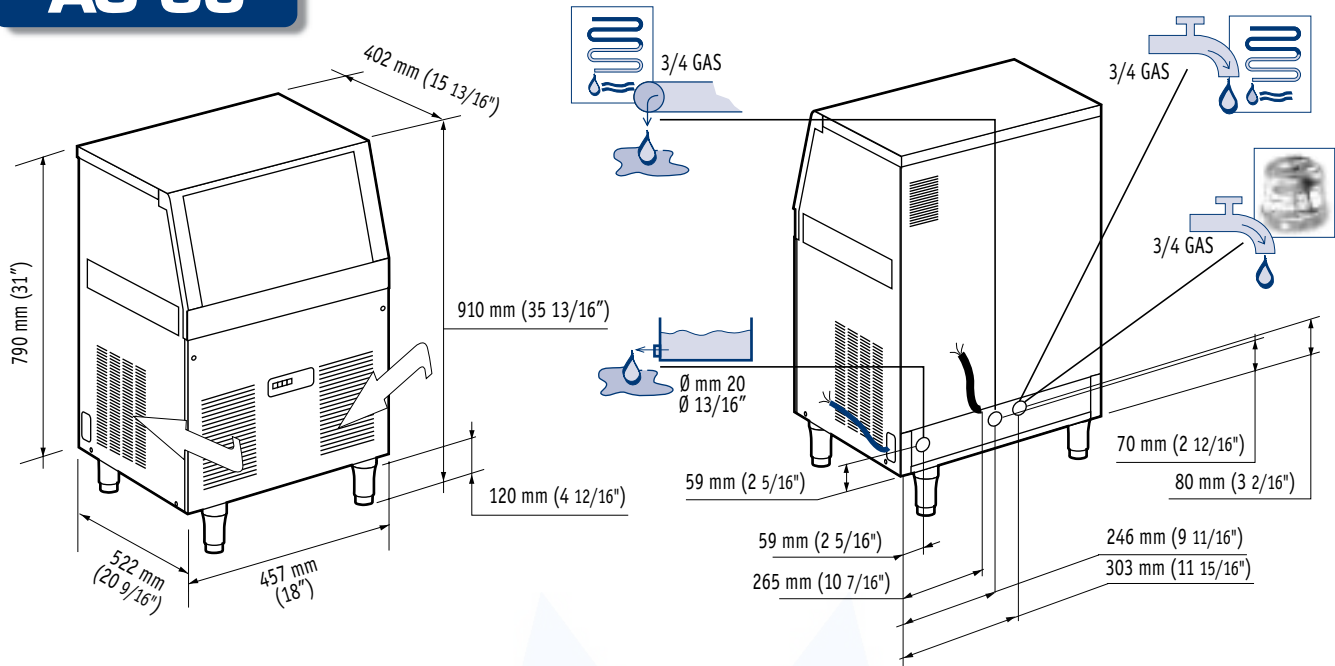

		-°C +°C	[Btu/h] [W]	[Ømm ²]	[W]	Fuse [A]	[kWh] 24h	[L/h] [gal/h]	32°C 90°F 21°C 70°F	[kg] [lbs]	[kg] [lbs]	[kg] [lbs]	
AC M 85 AS			4235 1245	3x1.5	500	10	10	5.8 1.5		48 105	55 121		
AC M 85 WS			4235 1245	3x1.5	500	10	10	30 7.9		47 103	54 119		
AC L 85 AS			4235 1245	3x1.5	500	10	10	5.5 1.4		48 105	55 121		
AC L 85 WS			4235 1245	3x1.5	500	10	10	28.5 7.5		47 103	54 119		

ACM 85 AIR COOLED



°C	50°	60°	70°	90°	
10°	39	37.5	36	33	kg
50°	86	82.5	79	73	lbs
21°	38	36.5	35	32	kg
70°	83	80	77	70	lbs
32°	33.5	32	30.5	27.5	kg
90°	74	70	67	60.5	lbs
38°	32	30.5	29	26	kg
100	70	67	64	57	lbs



ACM 85 WATER COOLED



°C	50°	60°	70°	90°	
10°	40	38.5	37	34	kg
50°	88	85	81	75	lbs
21°	38.5	37	35.5	32.5	kg
70°	85	81	78	72	lbs
32°	37	35.5	34	31	kg
90°	81	78	75	68	lbs
38°	36	34.5	33	30	kg
100	79	76	73	66	lbs



Minimum	Maximum
10°C (50°F)	40°C (104°F)
5°C (41°F)	35°C (95°F)
-10%	+10%
1 BAR 14 psi	5 BAR 70 psi

Machine requires voltage indicated on rating name plate. Failures caused by improper voltage are not considered factory defects. Scotsman products are not designed for outdoor installation. Extended periods of operation at temperatures exceeding the above limitations constitutes misuse under the terms of Scotsman Limited Warranty, resulting in a loss.

La machine doit être raccordée conformément au voltage indiqué sur la plaque signalétique. Les éventuels dégâts causés par un non respect de cette consigne ne peuvent être considérés comme des défauts de fabrication. Les machines à glace Scotsman ne sont pas conçues pour être utilisées à l'extérieur. Le fonctionnement prolongé à des températures supérieures ou inférieures aux limites ci-dessus sont considérées comme une mauvaise utilisation dans le cadre de la garantie Scotsman.

Der Eisbereiter benötigt eine Stromspannung gemäß Geräte-Typenschild. Störungen oder Ausfälle, durch den Betrieb mit falscher Stromspannung sind keine Fabrikationsfehler und fallen nicht unter Garantie. Scotsman Eisbereiter sind nicht für die Installation im Freien geeignet. Der längere Betrieb bei Temperaturen über den obigen Grenzwerten ist eine falsche Anwendung und bedeutet den Verlust der Garantieleistung.

Los requerimientos eléctricos de la máquina están indicados en la placa de características. Los daños causados por voltajes inadecuados no son considerados defectos de fábrica. La máquinas de hielo Scotsman, no están diseñadas para trabajar a la intemperie. Largos periodos de funcionamiento a temperaturas que excedan de las limitaciones indicadas, constituyen maltrato de acuerdo con las observaciones de Scotsman.

La macchina richiede il voltaggio indicato sulla targhetta di identificazione. Danni causati da voltaggi diversi non sono considerati difetti di produzione. I prodotti Scotsman non vanno utilizzati all'aperto. Un prolungato periodo di utilizzo al di fuori delle temperature indicate non è consentito e causa l'automatico decadere della garanzia.



Scotsman®

Ice Systems

The one the world relies on.

Certified ISO 9001:2000

USA, Canada, Latin America
Scotsman Ice Systems USA
775 Corporate Woods Parkway
Vernon Hills, IL 60061
Ph: (+1) 847 215-4550
Fax: (+1) 847 913-9844
customer.service@scotsman-ice.com

Europe
Scotsman Europe-Frimont S.p.A.
Via Puccini, 22
20010 Pogliano (Milano) Italy
Ph: (+39) 02-93960208
Fax: (+39) 02-93960201
scotsman.europe@frimont.it

Asia and Pacific
Scotsman Ice Systems-Frimont S.p.A. (R.O.)
627A Aljunied Road-#04-04 Biztech Centre
Singapore 389842
Ph: (+65) 6738 5393
Fax: (+65) 6738 1959
scotsice@singnet.com.sg

China
Scotsman Ice Systems
258 Tong Ren Road Golden Tower 7A
Shanghai-200040 Peoples Republic of China
Ph: (+86) 21-62476056
Fax: (+86) 21-62476126
scotsmansh@online.sh.cn

Middle East & N. Africa
Scotsman Ice Systems Dubai Office
P.o. Box 13205 - Deira
Dubai - U.A.E.
Mobile: Ph: (+971) 505505980
Fax: (+971) 6-5654063
scotsman@emirates.net.ae

South Africa
Scotsman Ice Systems SA (PTY) Ltd.
10, Rhodes Street - Kensington B
P.o. Box 44 - Riverclub 2149
Ph: (+27) 11-7898400
Fax: (+27) 11-7898411
scotsman@telkomsa.net