

# Bedienungsanweisung

## Backwarentiefkühlschrank **NC81N**

[Art. 474600400604]



## **Wir gratulieren Ihnen zum Erwerb unseres Geräts!**

Die Arbeit ist einfacher aufgrund der intuitiven Graphik der Benutzerschnittstelle, entwickelt zur Vereinfachung des Zugangs zu den Funktionen, die so dargestellt werden, dass sie sofort gefunden werden, um die Interaktion zwischen Benutzer und Gerät zu verbessern.

In einer einzigen Maschine ein Konzentrat von Technologie, das es gestattet, für eine bessere Effizienz in der Küche verschiedene komplementäre Aktivitäten auszuführen.

Das vorliegende Handbuch hat den Zweck, alle Informationen für die richtige Benutzung des Geräts sowie eine angemessene Wartung zu liefern.

Vor allen Eingriffen müssen die enthaltenen Anweisungen aufmerksam gelesen werden, da sie unverzichtbare Angaben zur Sicherheit des Geräts enthalten.





## Sicherheitshinweise zur Benutzung

- Eine Benutzung und Reinigung, die von den Angaben im vorliegenden Handbuch abweichen, sind als Zweckentfremdung anzusehen und können zu Schäden, Verletzungen und tödlichen Unfällen führen; sie führen zum Verfall des Gewährleistungsanspruches und entbinden den Hersteller von jeglicher Haftung.
- Lesen Sie vor der Benutzung des Geräts aufmerksam das vorliegende Handbuch und bewahren sie es auf, damit es von den verschiedenen Bediener in der Zukunft konsultiert werden kann.
- Übergeben Sie das Handbuch im Fall der Abtretung des Gerätes an den neuen Benutzer.
- Die Benutzung ist ausschließlich geeignetem und geschultem Personal vorbehalten, das sich periodisch weiterbilden muss.
- Nähern Sie sich den elektrischen Bauteilen nicht mit nassen Händen oder barfuß an.
- Es ist absolut untersagt, Eingriffe oder Abänderungen an den Sicherheitsvorrichtungen vorzunehmen (Schutzgitter, Gefahrenaufkleber usw.). Der Hersteller übernimmt keinerlei Haftung, falls die vorausgehenden Anweisungen nicht beachtet werden.
- Stecken Sie keine Schraubenzieher oder sonstige Gegenstände durch die Schutzvorrichtungen (Schutzvorrichtungen von Gebläsen, Verdampfern usw.).
- Verstopfen Sie für den ordnungsgemäßen Betrieb von Kompressor und Verdampfer nie die Lüftungsöffnungen.
- Verwenden Sie im Brandfall kein Wasser, verwenden Sie einen CO<sub>2</sub>-Löscher und kühlen Sie so schnell wie den Bereich des Motorraums.

## Ordnungsgemäße Verwendung des Geräts

- Dieses Gerät gilt als lebensmittelverarbeitende Maschine (EU-Verordnung Nr. 1935/2004) und des ist für die Verarbeitung von Lebensmitteln in industriellen Großküchen bestimmt. Es ist nicht geeignet für die Konservierung von pharmazeutischen sowie chemischen Produkten oder sonstigen Non-Food-Produkten.
- Zur Erzielung der bestmöglichen Leistungen des Geräts müssen die folgenden Anweisungen beachtet werden:
  - Stellen Sie keine warmen Lebensmittel oder nicht abgedeckte Flüssigkeiten, lebende Tiere oder korrosive Produkte in das Gerät.
  - Verpacken oder schützen Sie die Lebensmittel auf sonstige Weise, vor allem, falls sie Aromen oder Gewürze enthalten.
  - Lagern Sie die Vorräte so im Gerät, dass die Zirkulation der Luft nicht behindert wird, vermeiden Sie es, Papier, Kartons, Schneidebretter usw. auf die Gitter zu legen, die die Zirkulation der Luft behindern.
  - Vermeiden Sie so weit wie mögliches das häufige und längere Öffnen der Tür/Türen.
  - Warten Sie nach dem Öffnen der Tür einige Momente, bevor Sie sie erneut öffnen.
  - Ordnen Sie die Lebensmittel nach und nach von unten nach oben an und entnehmen Sie sie von oben nach unten.
- Die Kühlgeräte wurden mit den entsprechenden Maßnahmen gefertigt und entwickelt, um die Sicherheit und die Gesundheit des Benutzer zu gewährleisten und sie weisen keine gefährlichen scharfen Kanten oder überstehenden Bauteile auf. Ihre Stabilität ist auch bei offenen Türen gewährleistet, es ist jedoch untersagt, sich an die Türen zu hängen.
- Die Nichtbeachtung dieser Vorschriften kann zu Schäden sowie auch tödlichen Verletzungen führen und führt zum Verfall des Gewährleistungsanspruches.

## Bei Funktionsstörungen des Geräts...

- Unterbrechen Sie die Stromversorgung und die Wasserzufuhr und wenden Sie sich an den Vertragskundendienst des Herstellers, falls das Gerät nicht funktioniert oder falls Sie funktionelle oder strukturelle Veränderungen feststellen; versuchen Sie nicht, selbst Reparaturen auszuführen. Wir empfehlen die Verwendung von Originalersatzteilen. Der Hersteller haftet nicht, falls Ersatzteile von Drittanbietern verwendet werden.
- Um sicherzustellen, dass sich das Gerät im perfektem Nutzungs- und Sicherheitszustand befindet, empfehlen wir, es zumindest einmal jährlich durch den Vertragskundendienst warten zu lassen.



## Risiken im Zusammenhang mit der Benutzung des Geräts

- RISIKEN DURCH DIE BEWEGUNG AUF RÄDERN: Achten Sie bei den Bewegungen darauf, das Gerät nicht zu schnell zu schieben, falls es auf Rädern montiert ist, um zu vermeiden, dass es umkippt und beschädigt wird; achten Sie auch eventuelle Unebenheiten der Gleitflächen. Das mit Rädern ausgestattete gerät kann nicht nivelliert werden und daher muss sichergestellt werden, dass die Aufstellfläche vollkommen horizontal und eben ist. Blockieren Sie die Räder immer mit den entsprechenden Sperren.
- RISIKEN DURCH UMKIPPEN: Der Schrank muss nach dem Aufstellen mit entsprechenden Bügeln blockiert werden, da das Gewicht der Tür das Gleichgewicht nach vorne verlagert, was zu einer Kippgefahr führt. Falls der Schrank auf Rädern aufgestellt wird, ist es nicht möglich, ihn zu verankern, und daher ist beim Öffnen der Tür die **größtmögliche Vorsicht** erforderlich, vor allem bei leerem Gerät.
- RISIKEN DURCH BEWEGLICHE ELEMENTE: Das einzige bewegliche Element ist das Gebläse, es weist jedoch kein Risiko auf, da es durch ein mit Schrauben befestigtes Schutzgitter geschützt ist.
- RISIKEN DURCH HOHE/NIEDRIGE TEMPERATUREN: In der Nähe der Gefahrenbereiche durch hohe/niedrige Temperaturen wurden Aufkleber mit den Hinweisen „GEFAHR TEMPERATUR“ angebracht.
- RISIKEN DURCH ELEKTRISCHE ENERGIE: Die elektrischen Risiken wurden durch elektrische Anlage gemäß den Bestimmungen der Norm CEI EN 60335-1 gelöst. Aufkleber mit dem Hinweis „HOCHSPANNUNG“ weisen eine die elektrischen Gefahrenbereiche hin.
- Geräuschpegel unter 70 dB
- Darauf achten, dass beim Schließen der Tür die Finger nicht gequetscht werden.
- Wenn die Tür offen ist, steht das Armaturenbrett über die Abmessungen der Maschine über; aus diesem Grund muss darauf geachtet werden, nicht mit dem Kopf anzustoßen.
- Der Griff steht über die Abmessungen der Maschine über; darauf achten, eine möglichen Anstoßen zu vermeiden.

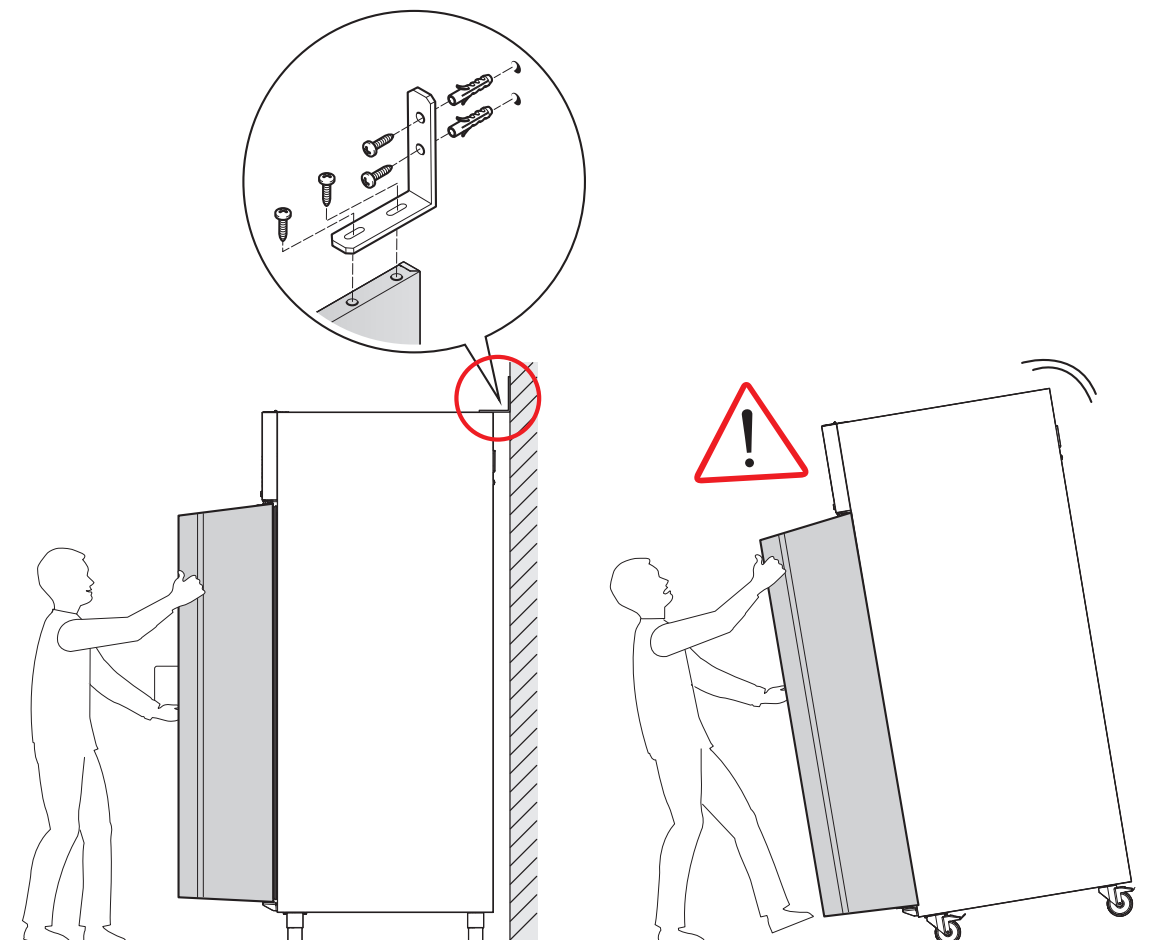

## Richtiges beladen des Geräts

Die Speisen werden in einer einzigen Schicht in Behältern angeordnet:

- offen;
- lebensmittelgeeignet;
- widerstandsfähig gegen niedrige Temperaturen;

Die Behälter müssen gleichmäßig im Inneren der Kammer verteilt werden.

Ein korrekte Positionierung der Behälter gestattet die frei Zirkulation der Luft im Inneren der Zelle: Verstopfen Sie die Lüftungsgebläse nicht und vermeiden Sie die Überladung des Geräts.

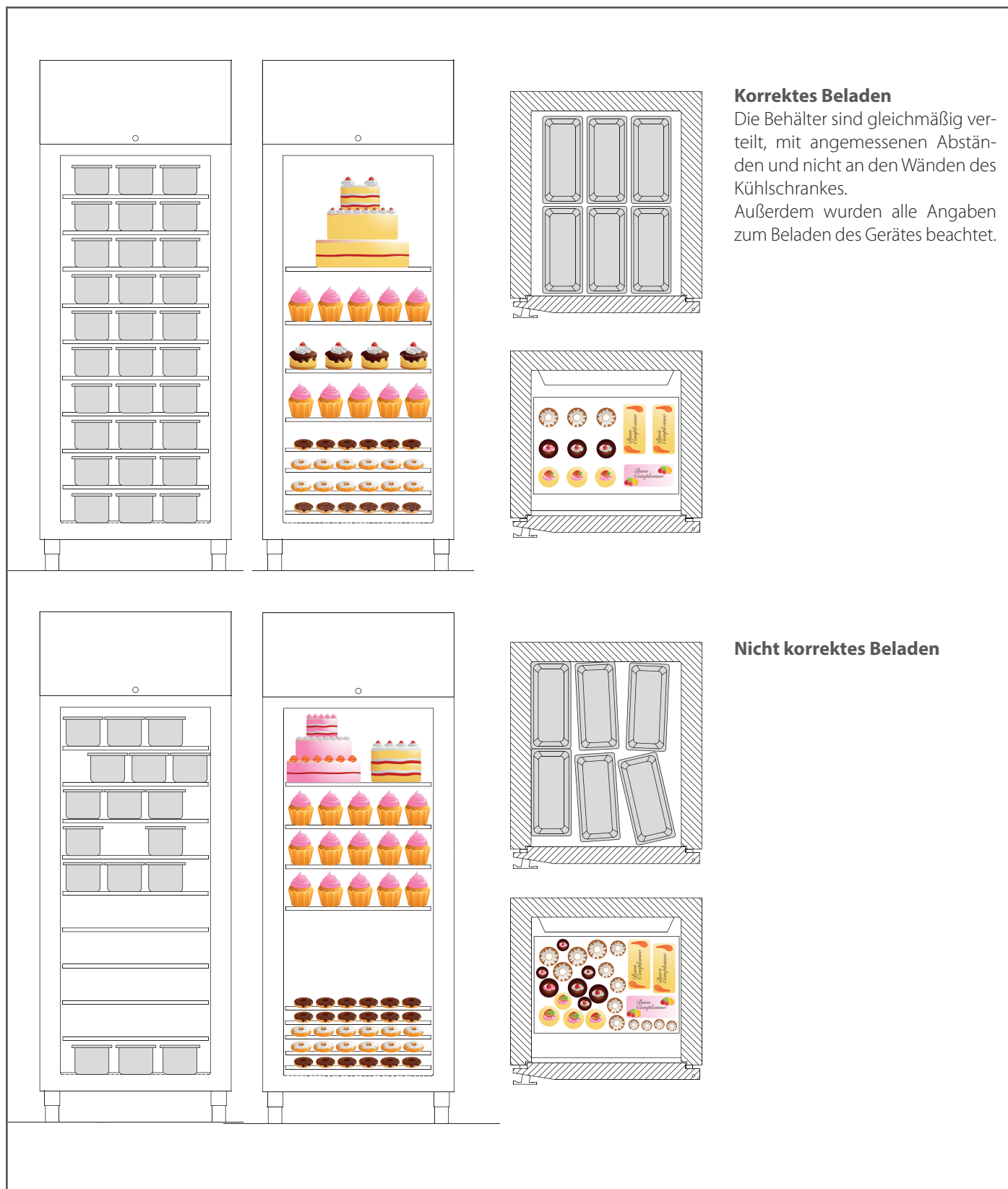

### Korrektes Beladen

Die Behälter sind gleichmäßig verteilt, mit angemessenen Abständen und nicht an den Wänden des Kühlschranks.

Außerdem wurden alle Angaben zum Beladen des Gerätes beachtet.

### Nicht korrektes Beladen

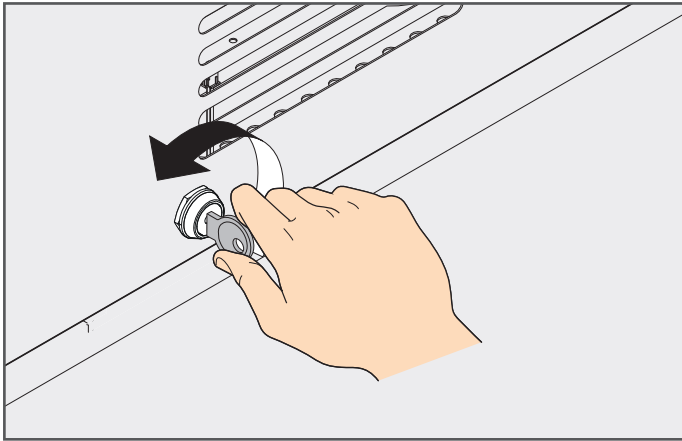

## Blockieren der Tür

Die Öffnung der Tür kann mit dem Schloss auf dem Armaturenbrett blockiert werden.

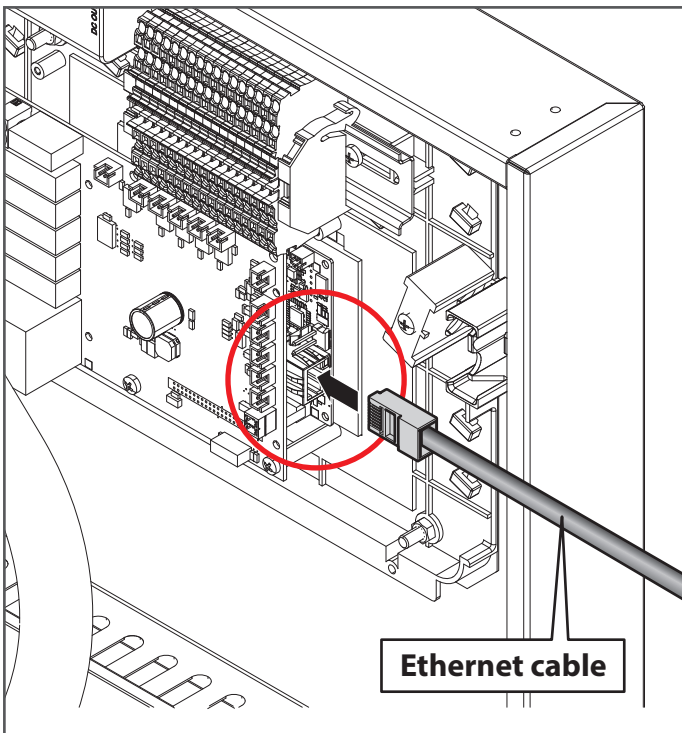

## Cloud-Verbindung

Wenn der Kunde ein Cloud-Abonnement beantragt hat, wird die Maschine mit einem Ethernet-Kabel mit dem Netz verbunden. Der Anschluss befindet sich auf der Karte im hinteren Teil des Armaturenbretts.

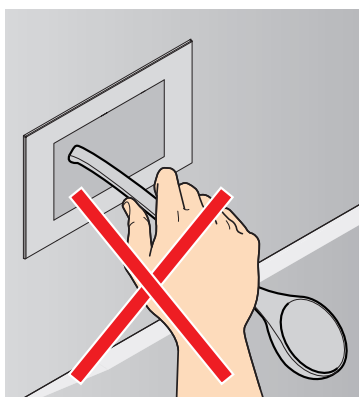
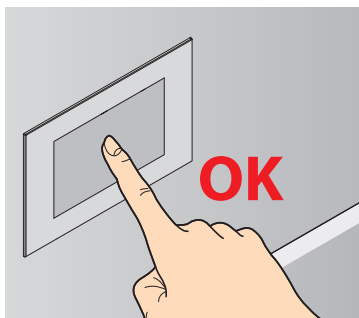

Wir empfehlen, den Display nicht mit Kellen oder sonstigen Gegenständen zu berühren, sondern nur mit den Händen oder eventuellen Stiften für Touchscreens.

Seite 11

## Menü Benutzung

Zur Benutzung der Maschine müssen nur eingestellt werden:



die **Temperatur** im Inneren des Gerätes;



die **Feuchtigkeit** im Inneren des Gerätes;



die **Rotationsgeschwindigkeit der Gebläse**.

Seite 16

## Kontinuierlich kalt

Wenn aktiviert, arbeitet die Maschine kontinuierlich (Kompressor immer in Betrieb). Die Funktion ist nützlich, wenn große Mengen Lebensmittel geladen werden müssen und wenn die Tür daher oft und lange geöffnet wird.



Funktion nicht aktiv



Funktion aktiv

## Bereich Hinweise

Liefert Angaben zum Status der Maschine  
Wenn an, zeigt an:



die Tür ist offen



die Maschine ist mit der Cloud verbunden (wenn der Kunde ein Abonnement beantragt hat)



die Gebläse sind in Betrieb



der Kompressor ist in Betrieb

die Maschine ist in Energieeinsparung, das heißt, sie hält in den Zeiten mit wenig Arbeit eine höhere Temperatur aufrecht, bezogen auf den Set (zum Beispiel nachts). Die Parameter ES3 und ES4 legen den Sollwert der Temperatur fest, der aufrecht erhalten wird, wenn die Bedingung auftritt



die Maschine befindet sich in der Phase Abtauen

Seite 17

## Menü Einstellungen

Gestattet es, einige Einstellungen der Maschine und der Sets vorzunehmen.



## Licht

Schaltet die LEDs im Armaturenbrett oder in der Tür ein/aus.

Seite 12

## Menü Rezepte

Gestattet das Anzeigen der **Liste der zuvor vom Benutzer abgespeicherten Sets**, der vom Hersteller gespeicherten Sets der die **Erstellung eines neuen Sets** mit Zuordnung von Name und Parametern auf Grundlage der eigenen Bedürfnisse.

Seite 16

## Menü Benachrichtigungen

Anzeige eventueller aufgetretener Alarme

Seite 16

## Menü Statistiken

Liefert Informationen zu:
 

- Variationen der Temperatur;
- Variationen der Feuchtigkeit während der letzten 12 Stunden.



Max. Betriebstemperatur: 43°C

## Erste Einschaltung

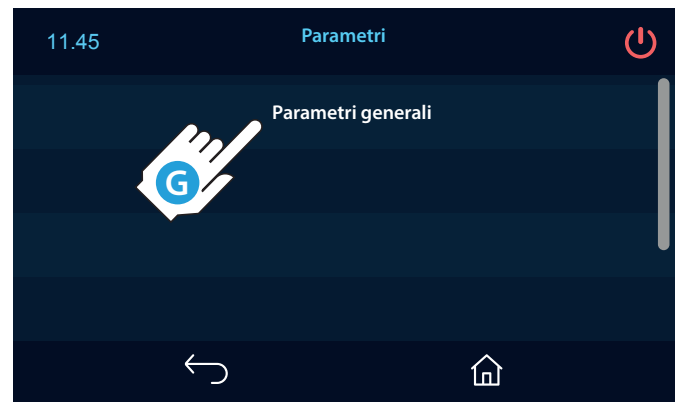
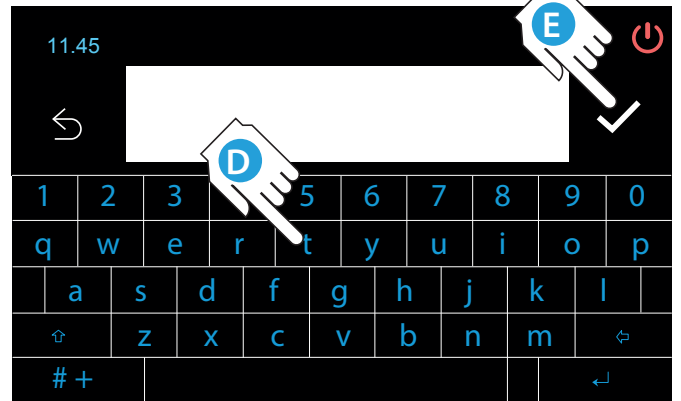
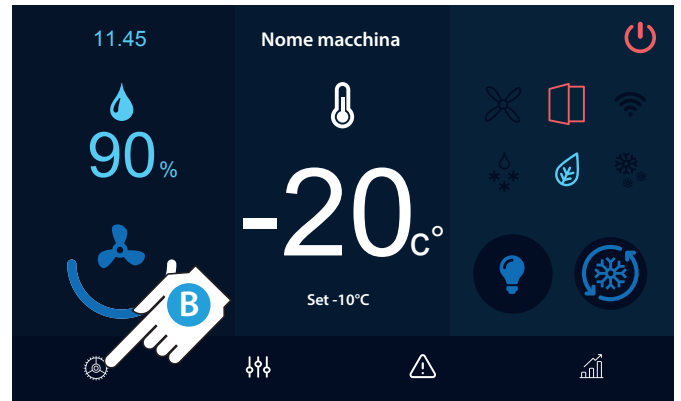





## Menü Benutzung





### Die Betriebsparameter einstellen

Zur Benutzung der Maschine müssen nur eingestellt werden:

-  die **Temperatur** im Inneren des Gerätes;
-  die **Feuchtigkeit** im Inneren des Gerätes;
-  die **Rotationsgeschwindigkeit der Gebläse**.





**A** Die Maschine durch Berühren der Taste ON-OFF einschalten.

**B** Wenn das Display für einige Minuten nicht berührt wird, wechselt die Maschine zum Standby: Zum verlassen dieses Zustands ist es ausreichend, das Display an beliebiger Stelle zu berühren.

- C** Den betreffenden Parameter einstellen:
- C1** das einzustellende Feld berühren (zum Beispiel "Temperatur");
  - C2** die Tasten  und  betätigen, bis der gewünschte Wert angezeigt wird;
  - C3** mit  bestätigen oder mit  annullieren.

**D** Auf der Bildschirmanzeige werden angezeigt:

**D1** die Statussymbole der Maschine:

-  die Tür ist offen
-  die Maschine ist mit der Cloud verbunden (wenn der Kunde ein Abonnement beantragt hat)
-  die Gebläse sind in Betrieb
-  der Kompressor ist in Betrieb

die Maschine ist in Energieeinsparung, das heißt, sie hält in den Zeiten mit wenig Arbeit eine höhere Temperatur aufrecht, bezogen auf den Sollwert (zum Beispiel nachts). Die Parameter ES3 und ES4 legen den Sollwert der Temperatur fest, der aufrecht erhalten wird, wenn die Bedingung auftritt

-  die Maschine befindet sich in der Phase Abtauen

**D2** effektive Temperatur und Feuchtigkeit in der Zelle

**D3** Geschwindigkeit Gebläse

 Während des Betriebs der Maschine ist es immer möglich, die Parameter zu ändern; dazu wie bei der Einstellung vorgehen.



**D2** effektive Temperatur und Feuchtigkeit in der Zelle

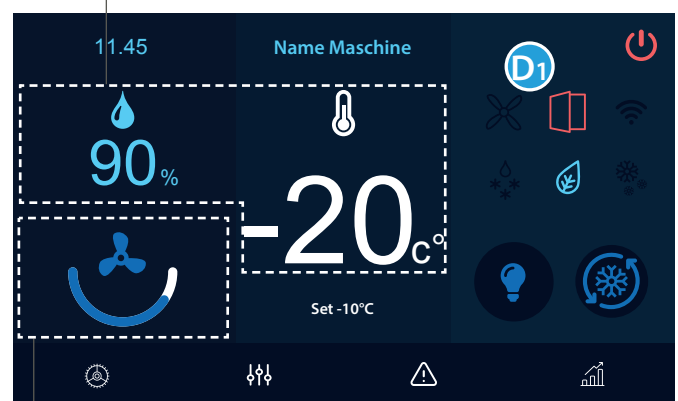

**D3** Geschwindigkeit Gebläse

## Menü Rezepte

### Einen eingestellten Set speichern



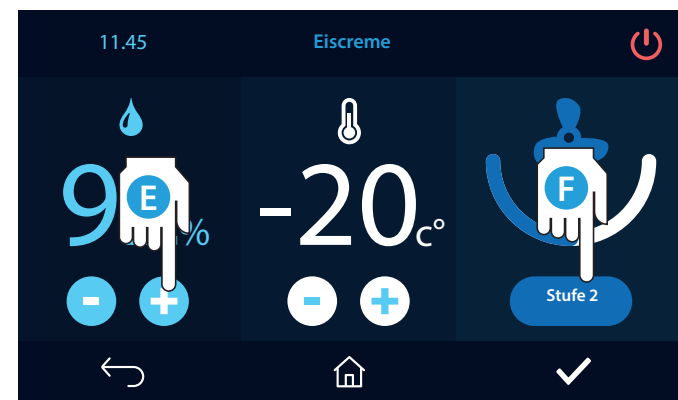
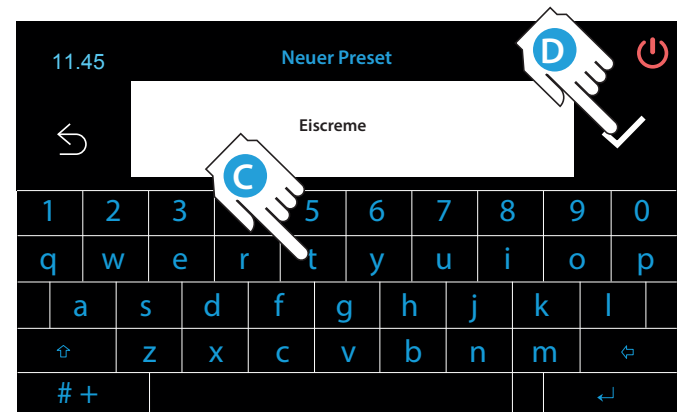
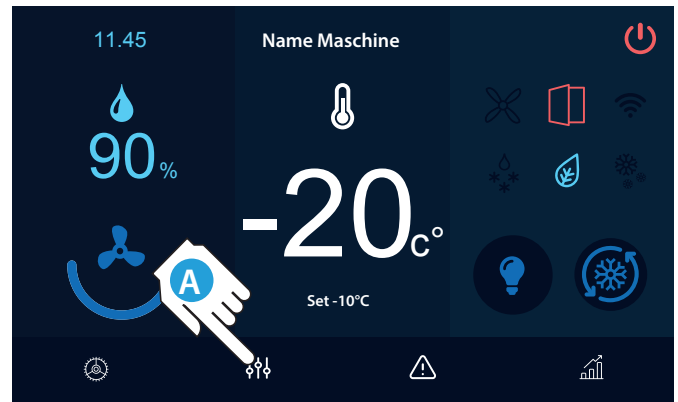

Nach der Einstellung der drei Parameter (Temperatur, Feuchtigkeit, Gebläsegeschwindigkeit) ist es möglich, sie zu **speichern** und dem soeben eingestellten Set einen Namen zuzuordnen (z. B. Eiscreme); dies gestattet es, den Sollwert erneut zu verwenden, ohne dass die Parameter jedes Mal neu eingegeben werden müssen.

- A** Das Feld "Rezepte" berühren.
- B** Die Taste **+** berühren.
- C** Den Namen eingeben, der dem Set zugeordnet werden soll (z. B. Eiscreme).
- D** Mit **✓** bestätigen oder mit **↶** annullieren.
- E** Es erscheint eine Bildschirmanzeige, die die Parameter des Sets zusammenfasst; falls erforderlich ist es möglich, sie wie üblich mit den Tasten **-** und **+** zu **ändern**.
- F** Durch Berühren der Taste **✓** bestätigen.



## Einen gespeicherten Set löschen, ändern oder duplizieren

- A** Das Feld "Rezepte" berühren.
- B** Den Namen des betreffenden Sets berühren (z. B. "Schokolade"): es erscheinen verschiedene Symbole, die es gestatten:

-  den Sollwert zu **löschen**;
-  die drei Parameter (Temperatur, Feuchtigkeit, Gebläsegeschwindigkeit) des Sets permanent zu **ändern**;
-  den Set zu **duplizieren**;
-  **den Set zu starten**.

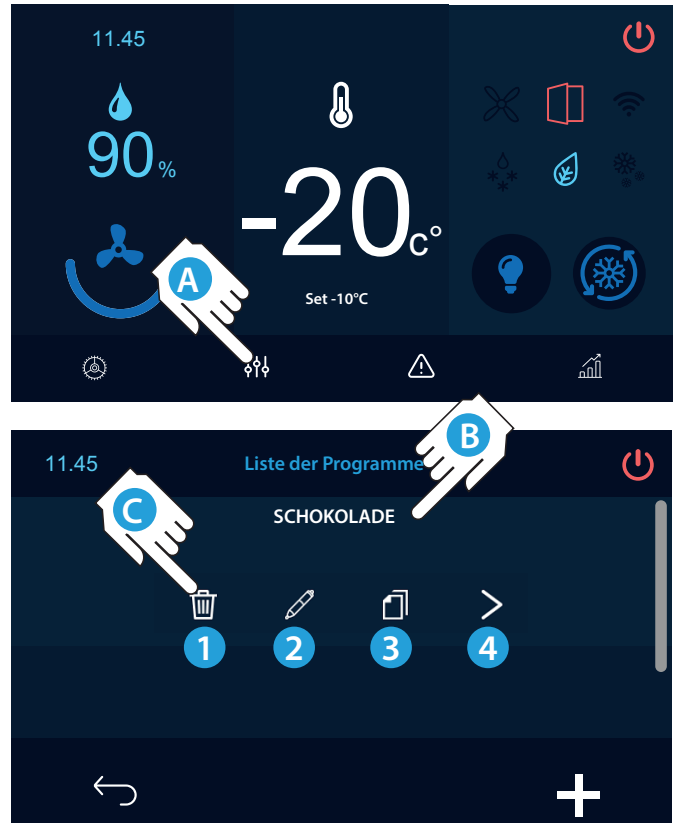

- C** Die gewünschte Option auswählen.

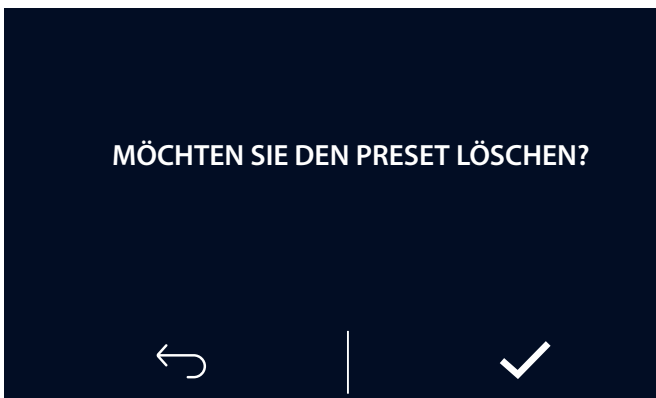

1





Den Set **löschen**: ein Pop-up-Fenster fordert zur Bestätigung der Löschung des Sets auf.

Den Vorgang mit  annullieren oder mit  bestätigen (in diesem Fall ist es nicht möglich, den gelöschten Set wiederherzustellen).

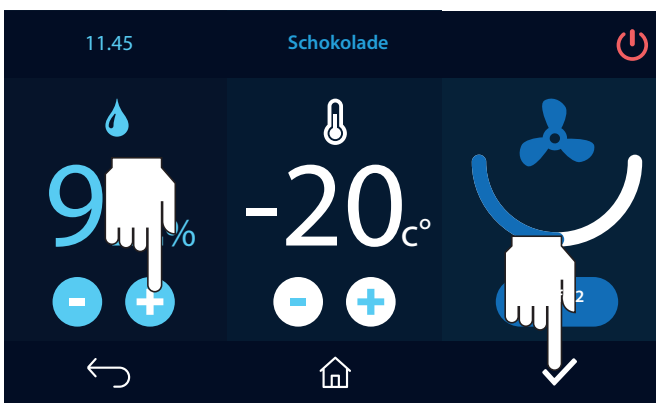
2



Die drei Parameter des Sets (Temperatur, Feuchtigkeit, Gebläsegeschwindigkeit) permanent mit den Tasten  und  **ändern**.

Durch Berühren der Taste  bestätigen.

Ab diesem Zeitpunkt arbeitet der Set mit den neuen Parametern.

*Beispiel:*

*Ausgangsdatei:* Schokolade -20°; 90%; v.1

*Datei mit geänderten Parametern:* Schokolade -20°; 95%; v.2

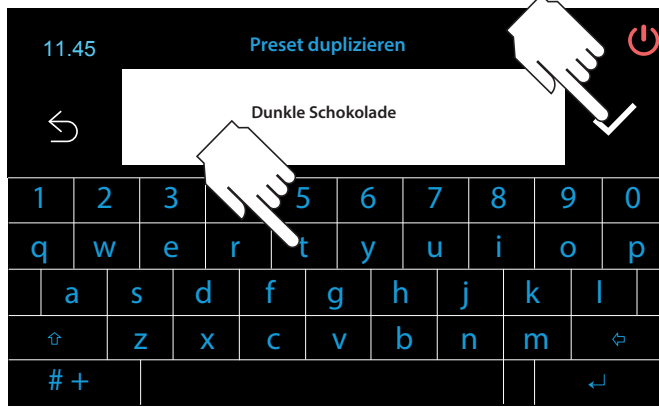

Den Set **duplizieren** (z. B. "Schokolade"), indem eine Kopie erstellt wird, der ein beliebiger Name zugeordnet werden kann (z. B. "dunkle Schokolade").

Die Kopie hat zu Beginn die gleichen Parameter wie das Original; diese Werte können wie üblich mit den Tasten **-** und **+** geändert werden.

Durch Berühren der Taste **✓** bestätigen.

Beispiel:

Ausgangsdatei: Schokolade -20°; 90%; v.1

duplizierte Datei: dunkle Schokolade -20°; 95%; v.2



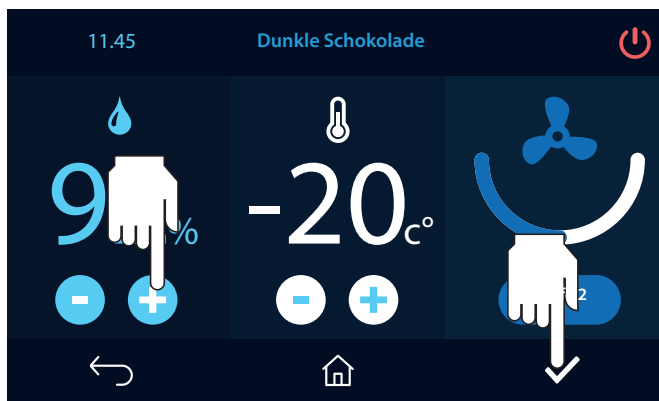

Bei Duplizieren eines Sets muss sein Name geändert werden, um zu vermeiden, dass die Ausgangsdatei überschrieben wird.



## Einen bereits vom Benutzer oder vom Hersteller gespeicherten Set starten

Die zuvor vom Benutzer abgespeicherten Zyklen oder die vom Hersteller gespeicherten befinden sich im Bereich "Rezepte". Um alle anzuzeigen, den Display berühren und von unten nach oben wischen (Funktion "Scroll").

Zum Starten eines bereits gespeicherten Sets:

- A** Das Feld "Rezepte" berühren: Die Liste alle zuvor abgespeicherten Sets erscheint (z. B. Eiscreme, Schokolade usw.).
- B** Den Namen des Sets berühren, das den eigenen Bedürfnissen entspricht: Es erscheinen verschiedene Symbole.
- C** Mit der Taste  starten: Es erscheint eine Bildschirmanzeige, die den Namen des aktuellen Sets und die Temperatur im Inneren des Schanks anzeigt.
- C** Während des Betriebs der Maschine ist es immer möglich, die Parameter des aktuellen Sets zu ändern, indem der zu ändernde Parameter berührt und wie üblich mit den Tasten  und  geändert wird. Mit  bestätigen oder mit  annullieren.

In diesem Fall ist auf der Bildschirmanzeige "aktueller Set" nicht mehr das gestartete Rezept aktiv und daher erscheint sein Name nicht mehr, sondern allgemein „set“.

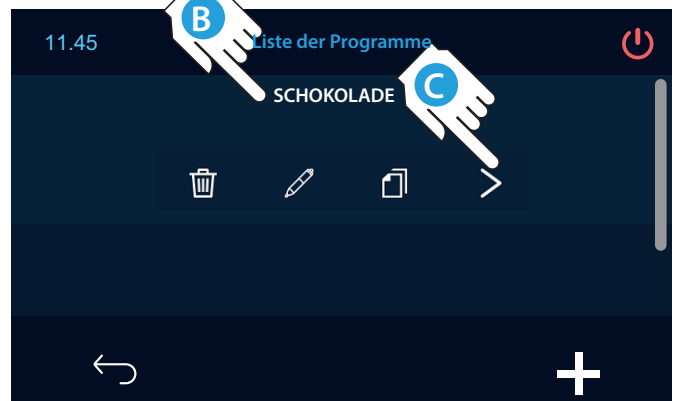

effektive Temperatur und Feuchtigkeit in der Zelle

BILDSCHIRMANZEIGE "AKTUELLER SET"

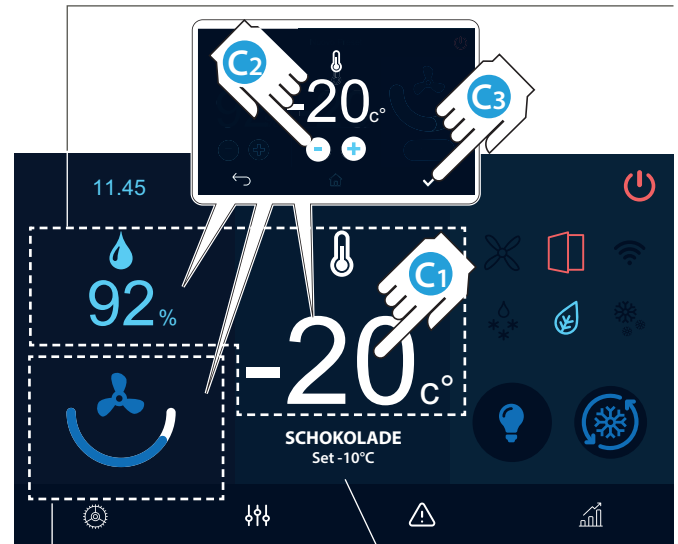

Geschwindigkeit Gebläse

Name des gestarteten Sets (z. B. Schokolade) und seine charakteristischen Parameter (-20°C und 90 %).

Wenn diese Parameter geändert werden (zum Beispiel durch Anheben der Temperatur auf - 18 °C) verschwindet der Name "Schokolade", um anzuzeigen, dass der gestartete Set nicht mehr aktiv ist.

## Menü Statistiken

Im Menü Statistiken werden die Variationen der Feuchtigkeit und der Temperatur der letzten 12 Stunden abgespeichert. Falls erforderlich ist es möglich, die Daten auf einem USB-Stick zu kopieren.

**A** Das Feld "Statistiken" berühren: Es erscheint eine Seite, die Informationen zur Variation der Temperatur und der Feuchtigkeit während des Tags liefert.

**B** Das betreffende Symbol berühren



liefert Variationen zum Verlauf der Temperatur



liefert Variationen zum Verlauf der Feuchtigkeit

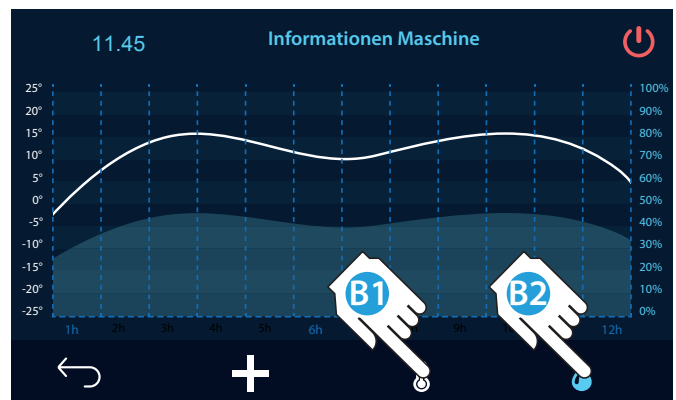
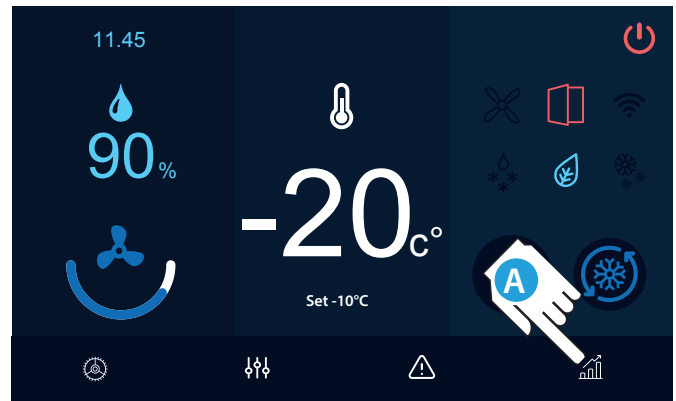

## Menü Benachrichtigungen

Die Bildschirmanzeige liefert die Liste der gegebenenfalls aufgetretenen Alarme.



## Kontinuierlich kalt

Wenn aktiviert, arbeitet die Maschine kontinuierlich (Kompressor immer in Betrieb) für eine Zeit von 30 Minuten.

Die Funktion ist nützlich, wenn große Mengen Lebensmittel geladen werden müssen und wenn die Tür daher oft und lange geöffnet wird.

Funktion nicht aktiv

Funktion aktiv

**A** Das Feld "Kontinuierlich kalt" berühren.

**B** Es erscheint eine Bildschirmanzeige mit einem Countdown von 30 Minuten.

Falls erforderlich ist es möglich, die Funktion vorzeitig zu blockieren, indem die Taste gedrückt wird oder indem die Zeit mit der Taste neu gestartet wird.

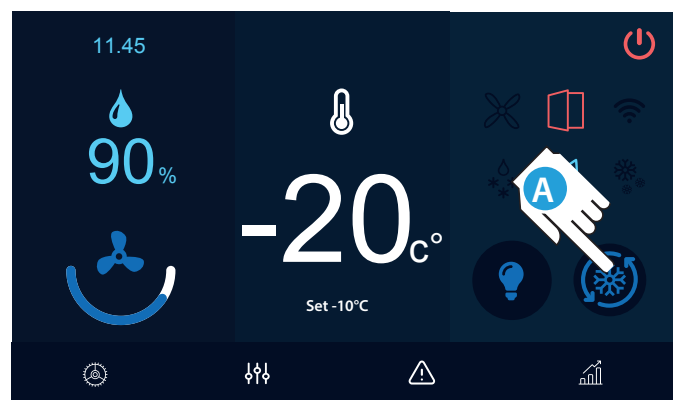

## Menü Einstellungen

- A** Das Feld "Einstellungen" berühren.
- B** Es erscheint eine Seite, die es gestattet, einige Einstellungen vorzunehmen:
- **manuelles Abtauen** (beim Berühren der Position startet das Abtauen sofort);
  - **Einstellung** Datum und Uhrzeit;
  - Auswahl der **Sprache**;
  - Zuweisung eines **Namens** zur Maschine;
  - Zugang zum **Menü Konfigurierung** der Parameter der Maschine; das Menü "Setting/service" ist qualifiziertem Personal vorbehalten und daher mit einem Passwort geschützt.

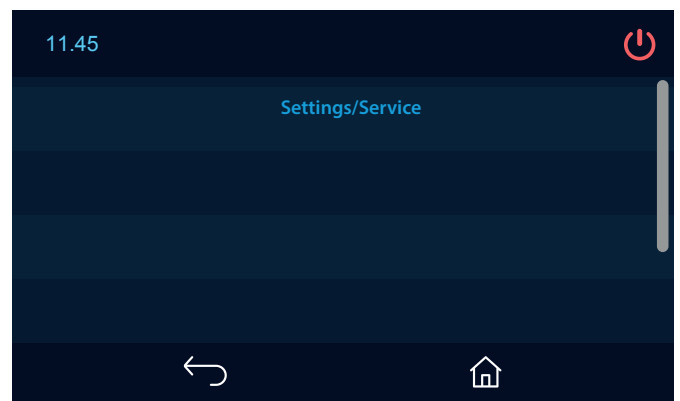
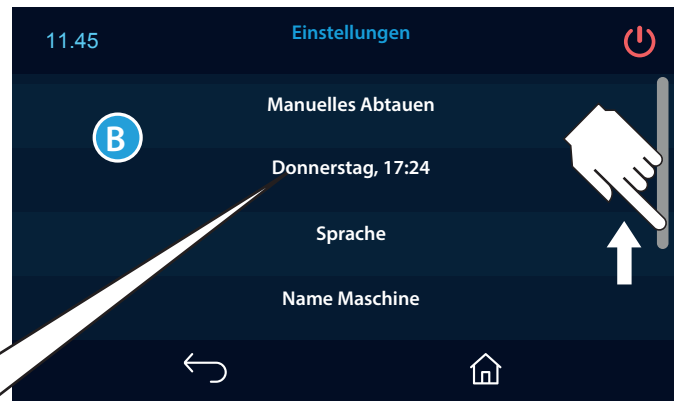
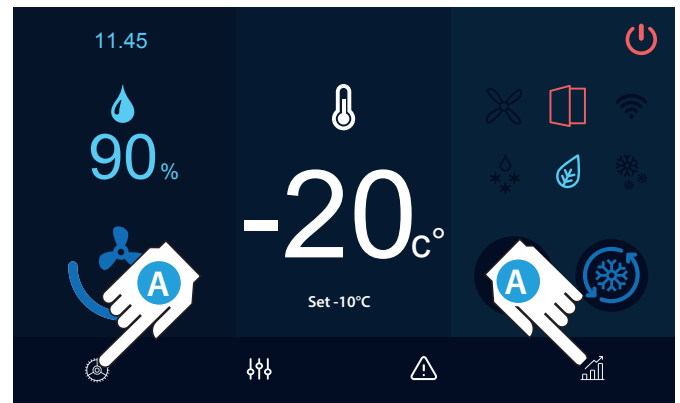
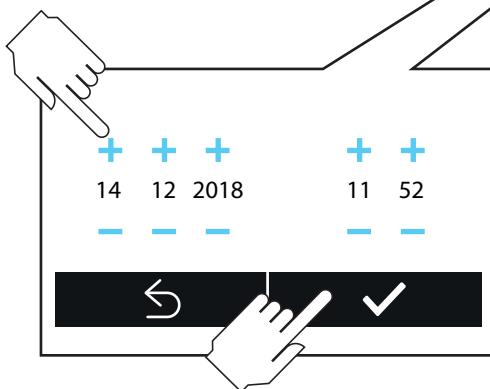

## Normale Reinigung des Gerätes



VOR DER DURCHFÜHRUNG ALLER WARTUNGSEINGRIFFE MUSS DIE STROMVERSORGUNG DES GERÄTS UNTERBROCHEN WERDEN; BENUTZEN SIE AUSSERDEM GEEIGNETE PERSÖNLICHE SCHUTZAUSSTATTUNGEN (Z. B. HANDSCHUHE USW.).



DER BENÜTZER DARF AUSSCHLIESSLICH ORDENTLICHE WARTUNGSARBEITEN (REINIGUNGSARBEITEN) AUSFÜHREN. BITTE WENDEN SIE SICH FÜR AUSSERORDENTLICHE WARTUNGSARBEITEN AN DEN VERTRAGSKUNDENDIENST UND BEANTRAGEN SIE EINEN EINGRIFF EINES TECHNIKERS.



DER GEWÄHRLEISTUNGSANSPRUCH VERFÄLLT IM FALL VON SCHÄDEN, DIE AUF UNTERLASSENE ODER FALSCH E WARTUNG ZURÜCKZUFÜHREN SIND (Z. B. VERWENDUNG UNGEEIGNETER REINIGUNGSMITTEL).



BEI DER DURCHFÜHRUNG VON WARTUNGS- UND REINIGUNGSARBEITEN AM MOTOR AUF HEISSE BAUTEILE ACHTEN.



AUF SCHARFE KANTEN AN DEN FÖRDERERN, DER KONDENSATORBATTERIE (DIE RIPPEN WERDEN VOM FILTER GESCHÜTZT), AN DER BASIS DER MOTORHALTERUNG (BOHRUNGEN) UND AN DEN LANGLÖCHERN DES ARMATURENBRETTS ACHTEN.

Zur Reinigung von Komponenten oder Zubehöerteilen dürfen NICHT verwendet werden:

- Scheuernde Reinigungsmittel in Pulverform;
- Aggressive oder korrosive Reinigungsmittel (z. B. Salzsäure oder Schwefelsäure, Ätznatron usw.). Achtung! Verwenden Sie diese Substanzen auch nicht zur Reinigung des Bodenbelags unter dem Gerät;
- Scheuernde oder spitze Werkzeuge (z. B. Scheuerschwämme, Schaber, Stahlbürsten usw.);
- Dampf- oder Hochdruckreiniger.

Reinigen Sie vor der ersten Benutzung die bleche und die Kammer mit einem mit warmer Seifenlaufe angefeuchtetem Tuch; anschließend nachspülen und abtrocknen. Zur Beseitigung von Arbeitsrückstände das Gerät ca. 30 Minuten leer in Betrieb nehmen.

## Reinigung der externen Stahlflächen

Ein dem warmer Seifenlauge oder spezifischen Produkten für Stahl getränktes Tuch verwendenacciaio. Anschließend nachspülen und abtrocknen.

## Reinigung der Kammer des Geräts

Reinigen Sie die Kammer des Geräts täglich, um die hohen Hygiene- und Leistungsniveaus des Geräts aufrecht zu erhalten. Zum Reinigen stets ein mit warmer Seifenlauge angefeuchtetes Tuch verwenden, anschließend nachspülen und trocknen.

PSA (persönliche Schutzausstattung), die bei der ordentlichen Wartung des Gerätes verwendet werden muss

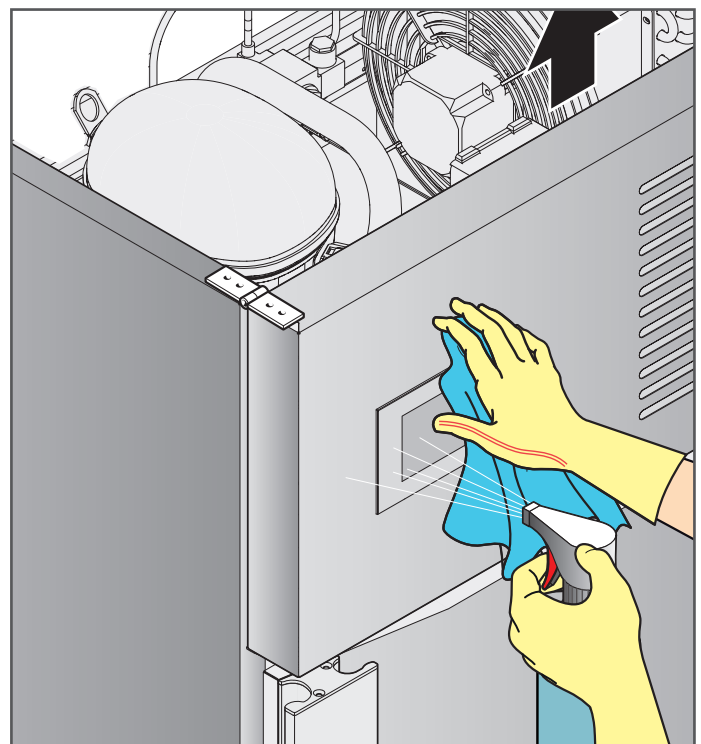
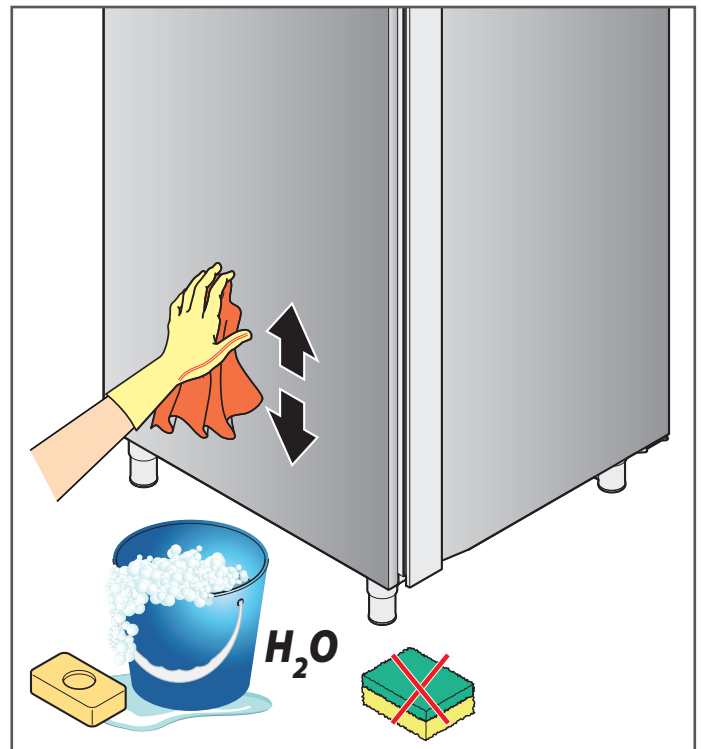



## Reinigung des Touchscreens

Ein mit ein wenig spezifischem Produkt für Bildschirme getränktes Tuch verwenden und die Anweisungen des Herstellers des Reinigungsmittels beachten.

Sprühen Sie nicht zu viel Produkt auf, um Infiltrationen zu vermeiden, die das Display beschädigen könnten.

## Reinigung der Schlitze und Gitter/Schwamm

Halten Sie die Schlitze durch häufige Reinigung mit einem Staubsauger oder einem Pinsel frei von Verkrustungen und Staub.

Wir empfehlen, das frontale Paneel in regelmäßigen Abständen anzuheben und den Staub abzusaugen, der sich auf dem Gebläse des Kondensators angesammelt hat. Durch Anheben des Paneels besteht auch Zugang zur Kondenswasserauffangschale, die sich zwischen Kondensator und Kompressor befindet. Darin fungiert ein Metallgitter "GM" als Schwamm, der das Wasser aufnimmt, die Austauschfläche vergrößert und die Verdampfung des Kondenswassers vereinfacht; dieses "Gitter/Schwamm" muss regelmäßig herausgenommen und mit Wasser und Seife oder in der Spülmaschine gereinigt werden.

## Reinigung des Filters

Auf der rechten Seite des Kondensators befindet sich ein Filter "FL", der von Metallklammern in Position gehalten wird. In regelmäßigen Abständen entfernen und mit Wasser und Seife reinigen. Nach der vollständigen Trocknung wieder in Position einsetzen. Die Maschine nicht ohne montierten Filter benutzen.

## Nichtbenutzungszeiten

Unterbrechen Sie während längerer Nichtbenutzung die Stromversorgung und die Wasserzufuhr (falls vorhanden). Schützen Sie die externen Bauteile aus Stahl des Geräts, indem Sie sie mit einem Öl oder Vaseline angefeuchtetem Tuch abreiben.

Lassen Sie die Tür angelehnt, damit die Luft zirkulieren kann.

Gehen Sie vor der erneuten Benutzung wie folgt vor:

- nehmen Sie eine sorgfältige Reinigung des Geräts und der Zubehörteile vor;
- schließen Sie das Gerät wieder an die Stromversorgung und die Wasserzufuhr an (falls vorhanden);
- unterziehen Sie das Gerät vor der erneuten Benutzung einer Kontrolle;
- nehmen Sie das Gerät für zumindest 60 Minuten ohne Lebensmittel in Betrieb.



**Um sicherzustellen, dass sich das Gerät im perfektem Nutzungs- und Sicherheitszustand befindet, empfehlen wir, es zumindest einmal jährlich durch den Vertragskundendienst warten zu lassen.**

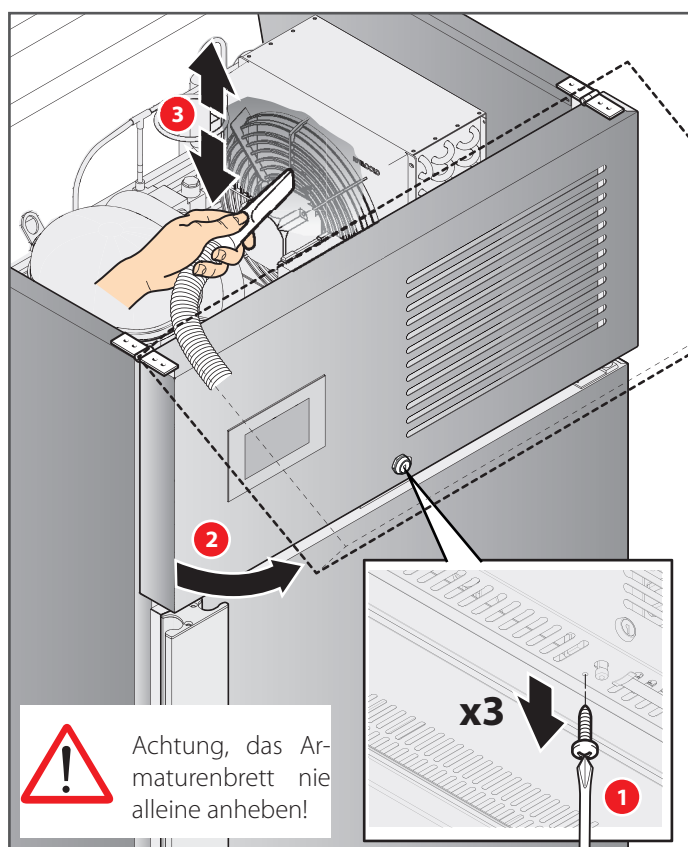
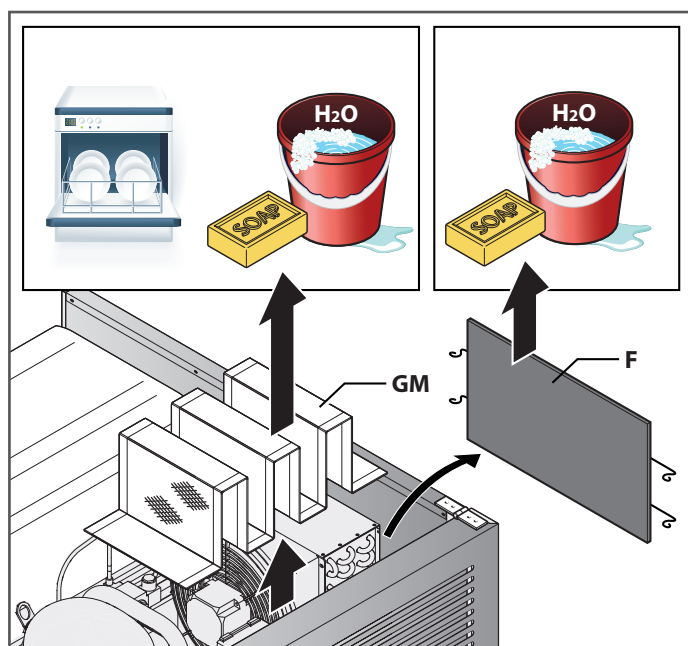
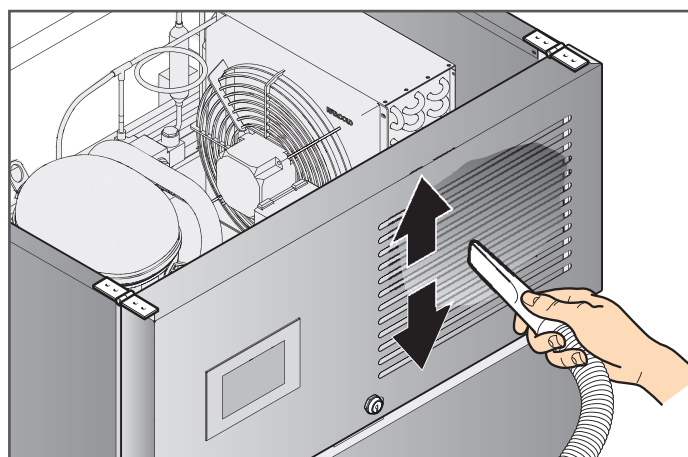

## Entsorgung

Das Abklemmen der Stromversorgung und der Wasserzufuhr muss durch qualifizierte Techniker erfolgen.

Falls vorhanden, müssen ordnungsgemäß entsorgt werden:

- Kühlgas;
- in den Hydraulikkreisläufen vorhandenen Frostschutzmittel,

Diese dürfen nicht in die Umwelt gelangen.

Gemäß den Bestimmungen von § 13 des ital. Gesetzerlasses Nr. 49 des Jahres 2014 „Umsetzung der EU-Richtlinie RAEE 2012/19 zu elektrischen und elektronischen Altgeräten“



Die Kennzeichnung mit der durchgestrichenen Mülltonne zeigt an, dass das Produkt nach dem 13. August 2015 in den Markt eingeführt wurde und, dass es nicht als Haushaltsabfall entsorgt werden darf, sondern separat entsorgt werden muss.

Alle Geräte bestehen zu mehr als 90 % des Gewichts aus recycelbare Metallen (Edelstahl, Eisen, Aluminium, verzinktes Blech, Kupfer usw.).

Machen Sie das Gerät für die Entsorgung unbrauchbar, indem Sie die Stromversorgung und alle Schließvorrichtungen (falls vorhanden) entfernen.

Bei der Entsorgung des Geräts muss darauf geachtet werden, dass negative Umweltauswirkungen vermieden werden und, dass die Ressourcen geschont werden, durch Anwendung des Prinzips „Wer verschmutzt, zahlt“ sowie durch Vorbeugung, Vorbereitung zur Wiederverwendung, Recycling und Verwertung.

Die unsachgemäße Entsorgung des Produkts führt zur Anwendung der von den geltenden gesetzlichen Bestimmungen vorgesehenen Sanktionen.

### Informationen zur Entsorgung in Italien

In Italien müssen RAEE-Geräte wie folgt entsorgt werden:

- durch Sammelstellen (auch Öko-Inseln oder Öko-Plattformen genannt)
- durch den Händler, bei dem ein neues Gerät erworben wird (Rücknahme „eins zu eins“);

### Informationen zur Entsorgung in Ländern der europäischen Union

Die EU-Richtlinie zu Geräten (RAEE) wurde in jedem Land auf andere Weise umgesetzt und daher empfehlen wir Ihnen, sich für die ordnungsgemäße Entsorgung des Geräts an die zuständige lokale Behörde oder den Händler zu wenden.



Bis zur Entsorgung kann das Gerät auch provisorisch im Freien gelagert werden, vorausgesetzt, Strom-, Kühl- und Wasserkreisläufe sind unbeschädigt und verschlossen. Stellen Sie außerdem sicher, dass die Türen nicht verschlossen werden können, um Einschließungen zu vermeiden.

Die gesetzlichen Umweltschutzbestimmungen im Land der Benutzung müssen in jedem Fall beachtet werden.

## Funktionsstörungen

Falls das Gerät nicht funktioniert oder falls funktionelle oder strukturelle Veränderungen festgestellt werden:

- Unterbrechen Sie die Stromversorgung und die Wasserzufuhr;
- Konsultieren Sie folgende Tabelle und überprüfen Sie die vorgeschlagenen Lösungen.

Wenden Sie sich an den Vertragskundendienst des Herstellers, falls in der Tabelle keine Lösung enthalten ist; dabei müssen angegeben werden:

- die Natur des Defekts;
- die Artikelnummer und die Seriennummer des Geräts, die auf dem Typenschild angegeben werden.

Verlangen Sie für die Reparatur originalersatzteile: Der Hersteller übernimmt keinerlei Haftung, falls Ersatzteile von Drittanbietern verwendet werden.



Um sicherzustellen, dass sich das Gerät in einem perfekten Nutzungs- und Sicherheitszustand befindet, empfehlen wir, es zu mindest einmal jährlich durch den Vertragskundendienst warten zu lassen.

1		2		3		4		5		6		7		8		9		10		11		12		13		14		15		16		17	
MATRICOLA-SERIE NR.-SERIAL NO. / NO. OE SERIE - رقم التسلسلي		CODICE - KODE - CODE - RÉFÉRENCE PRODUIT - رمز		MODELLO / TYPE / MODELE / MODEL		TENSIONE / TENSIE / TENSÃO / TENSIE		POTENZA / POWER / POTENCIA / POTENCIA		POTENZA / POWER / POTENCIA / POTENCIA		POTENZA / POWER / POTENCIA / POTENCIA		POTENZA / POWER / POTENCIA / POTENCIA		POTENZA / POWER / POTENCIA / POTENCIA		POTENZA / POWER / POTENCIA / POTENCIA		POTENZA / POWER / POTENCIA / POTENCIA		POTENZA / POWER / POTENCIA / POTENCIA		POTENZA / POWER / POTENCIA / POTENCIA		POTENZA / POWER / POTENCIA / POTENCIA		POTENZA / POWER / POTENCIA / POTENCIA		POTENZA / POWER / POTENCIA / POTENCIA		POTENZA / POWER / POTENCIA / POTENCIA	

1	Hersteller	10	Nennleistung anderer Widerstände
2	Seriennummer	11	Lampenleistung
3	Kode	12	Mindest- und Höchst- druck
4	Modell	13	Kühlmittel, Typ und Menge
5	Spannung	15	Gasisolierung
6	Stromaufnahme im Betrieb	16	Herstellungsjahr
8	Leistung Abtauwider- stand	17	Klimaklasse (#)
9	Leistung Abtauwider- stand		

### Typ des Problems

### Vor der Kontaktaufnahme mit dem Kunden- dienst überprüfen, ob...

das Gerät vollständig ausgeschaltet ist.

- ...elektrische Spannung in der Anlage vorhanden ist und der Netzstecker nicht herausgezogen worden ist.

Das Gerät kühlt nicht ausreichend

- ...kein Einfluss durch eine externe Wärmequelle vorhanden ist;  
 - ...die Türen perfekt geschlossen sind;  
 - ...der Filter des Kondensators verstopft ist;  
 - ...die frontalen Lüftungsöffnungen von Gegenständen oder Stab verstopft sind;  
 - ...die Lebensmittel im Inneren der Zelle gut verteilt sind und die Zirkulation der Luft im Inneren der Zelle nicht beeinträchtigen;  
 - ...das Gerät nicht mit Lebensmitteln überladen ist (halten Sie die Anweisungen zur Beladung des Geräts in Ihrem Besitz ein).

Das Gerät ist sehr laut

- ...keine Kontakte zwischen dem Gerät und anderen Gegenständen oder Maschinen vorhanden sind;  
 - ...das Gerät perfekt nivelliert ist;  
 - ...die sichtbaren Schrauben gut festgezogen sind.



Versuchen Sie nicht, das Gerät selbst zu reparieren; dies können zu schweren Schäden für Personen, Tiere und Gegenstände führen und führt zum Verfall des Gewährleistungsanspruchs.

Fordern Sie einen Eingriff des Vertragskundendienstes des Herstellers an und verlangen Sie Originalersatzteile.

## Garantie

Die Gewährleistungspflicht des Herstellers für Geräte und Bauteile aus seiner Produktion hat eine Dauer von einem Jahr ab dem Rechnungsdatum und sie besteht in der kostenlosen Lieferung von Bauteile, die nach seinem unanfechtbaren Urteil ausgetauscht werden müssen.

Der Hersteller wird die eventuellen Mängel beheben, vorausgesetzt, das Gerät wurde unter Beachtung der Anweisungen im vorliegenden Handbuch installiert und benutzt. Aus der Garantie ausgeschlossen sind Schäden durch Kalkverkrustungen, Überspannung oder Eingriffe durch Unbefugte.

Die Verbrauchsteile wie Scheiben, Bauteile mit ästhetischer Funktion, Dichtungen, Lampe und Verschleißteile sind aus der Garantie ausgeschlossen.

Während des Garantiezeitraums gehen die Arbeits-, Reise- und Transportkosten für die gegebenenfalls auszuwechselnden Geräte und Bauteile zu Lasten des Auftraggebers.

Die im Rahmen der Garantie ausgewechselten Materialien bleiben unser Eigentum und müssen auf Kosten des Auftraggebers zurückgeliefert werden.

NordCap GmbH & Co. KG  
Thalenhorststraße 15  
28307 Bremen  
Hauptsitz (Service, Finanzen & Personal, Lager, IT, Marketing)

Telefon: +49 421 48557-0  
Telefax: +49 421 488650  
E-Mail: [bremen@nordcap.de](mailto:bremen@nordcap.de)

Die NordCap Verkaufsniederlassungen in Deutschland:

Nord: Hamburg • Ost: Berlin • Süd: Ingelheim • West: Erkrath



# User Manual

## Bakery Cabinet **NC81N**

[Art. 474600400604]



## **Congratulations on having purchased our equipment!**

Work is simpler due to the intuitive user interface graphics, designed to simplify function access, that are displayed to be immediately identified and promote user and device interaction.

A concentration of technology in a single equipment allowing to perform different and complementary activities for the best efficiency in the kitchen.

This manual furnishes all necessary information necessary for correct device use and appropriate maintenance.

Read the instructions carefully before any operation, as they provide essential indications concerning the device safety state.



The manufacturer declines all responsibility for any unintended use of the product. Original language: Italian. The manufacturer is responsible for any transcription or translation mistakes.



## Safety instructions for use

- Use and cleaning other than those indicated and foreseen in this booklet are considered improper and can cause damages, injuries or fatal accidents, null and void the warranty and hold the manufacturer harmless from any liability.
- Read this manual carefully before using the equipment and maintenance and keep it for any further future consultation by the various operators.
- In the event that the equipment is transferred, give this manual to the new user.
- Use is solely reserved to appropriate and trained personnel who attend periodic refresher courses.
- Keep away from electrical parts with wet hands or bare feet.
- IT IS absolutely forbidden to tamper with or remove the supplied safety devices (protective grids, danger stickers, etc...). The manufacturer declines all responsibility if the above instructions are not followed.
- Do not insert screwdrivers or other objects between guards (fan guards, evaporator guards, etc.).
- For good compressor and evaporator unit operations, never obstruct the air vents.
- In the event of fire, do not use water. Install a CO<sub>2</sub> (carbon dioxide) extinguisher and cool the motor compartment as quickly as possible.

### Correct equipment use

- This equipment is considered a food processing machine (Regulation (EC) No 1935/2004), intended for the processing of food products in industrial and professional kitchens. It is not suitable for the storage of pharmaceutical, chemical or any other non-food product.
- The following instructions must be followed for best equipment performance:
  - Do not place hot food, uncovered liquids, live animals, various objects or corrosive products in the equipment.
  - Package or otherwise protect food especially if they contain aromas or spices.
  - Arrange foodstuffs inside the equipment to avoid limiting air circulation, avoiding placing paper, cardboard, cutting boards, etc- that can hinder air passage on the racks.
  - Avoid frequent and prolonged door opening as much as possible.
  - If the door was opened, wait a few seconds before re-opening it.
  - Gradually arrange food starting from the bottom up; vice versa, remove food starting from the top down.
- Refrigerators have been made and designed with the proper shrewdness to guarantee user's health and safety and do not have hazardous corners, shape surfaces or protruding elements from the specified areas. Their stability is guaranteed even when the doors are open; however, it is forbidden to hang on to the doors.
- Failure to follow these instructions could cause damages and injuries, even fatal, and null and voids the warranty.

### In the event of equipment malfunctions...

- If the equipment does not work or functional or structural alterations are noted, disconnect it from the power and water mains and contact a service centre authorised by the manufacturer without attempting to repair it on your own. The use of original spare parts is recommended. The manufacturer declines all responsibility for the use of non-original spare parts.
- To ensure that the device is in perfect use and safety conditions, we recommend you have it maintained and serviced by an authorised service centre at least once a year.





## Risks associated with equipment use

- **RISKS DUE TO MOVING ON WHEELS:** if the equipment is fitted with wheels, be careful not to push the equipment roughly when moving to prevent it from tipping over and being damaged, also pay attention to any unevenness of the sliding surface. The equipment fitted with wheels cannot be levelled, so make sure that the supporting surface is perfectly horizontal and flat. Always lock the wheels with the appropriate catches.
- **RISKS DUE TO TIPPING OVER:** the cabinet, once positioned, must be locked with special clamps as the weight of the door tends to list it to the right with the risk of tipping over. If the cabinet is placed on wheels, it is not possible to anchor it; therefore, we recommend to pay **the utmost attention** when opening the door, especially if the equipment is empty.
- **RISKS DUE TO MOBILE ELEMENTS:** the only mobile element is the fan but does not constitute any risk since it is protected by a protection grate secured with screws.
- **RISKS DUE TO LOW/HIGH TEMPERATURES:** stickers marked "TEMPERATURE HAZARD" were affixed near areas with low/high temperature risks.
- **RISKS DUE TO ELECTRICITY:** risks of electrical nature were resolved by designing electrical systems as per regulations CEI EN 60335-1. Special "high voltage" stickers identify areas with electrical hazards.
- Noise levels lower than 70 dB.
- Be careful not to get your fingers jammed when closing the door.
- When the door is open,, the dashboard protrudes from the machine's dimensions; for this reason, be careful not to hit your head.
- The handle protrudes from the machine's overall dimensions; pay attention to possible impacts.

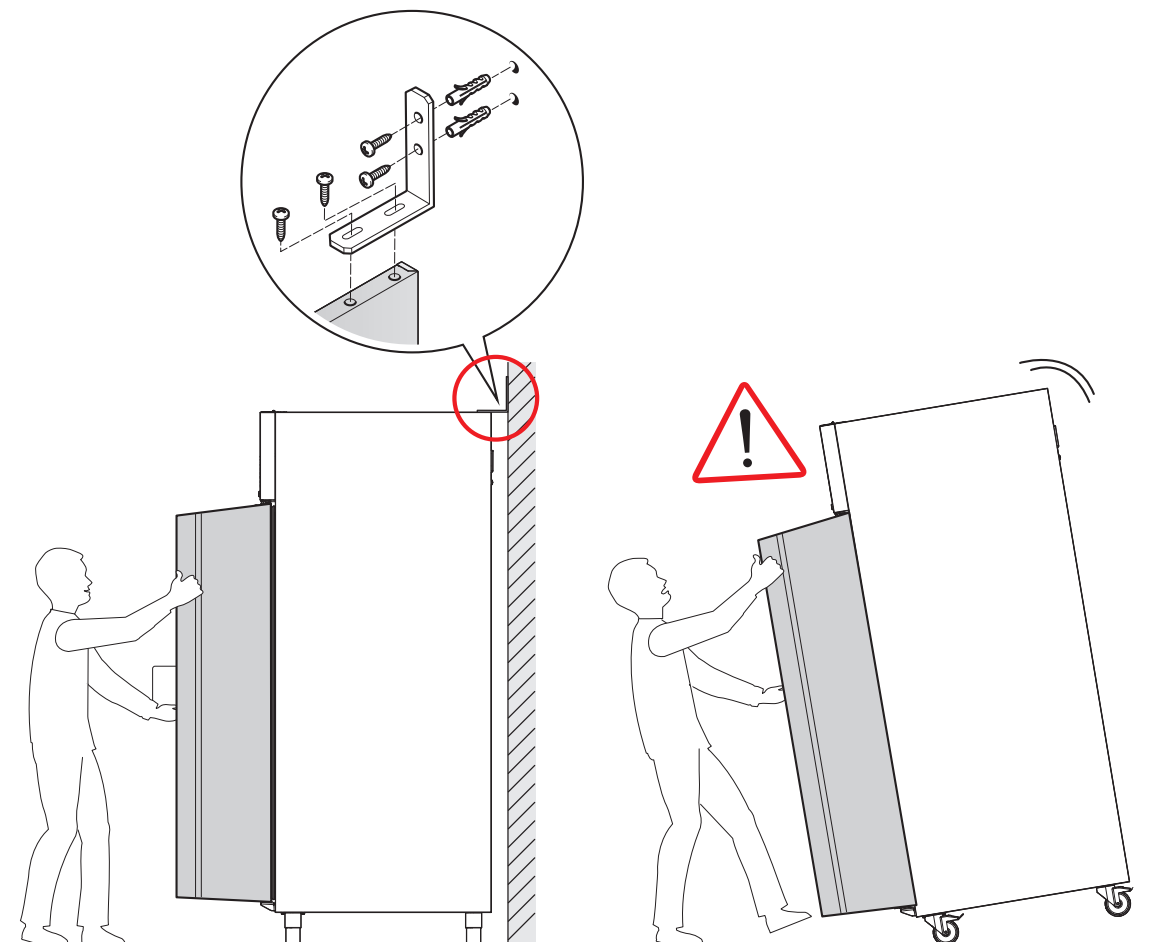

## Correctly loading the equipment

Food should be placed in a single layer in containers:

- uncovered;
- food-safe;
- resistant to low temperatures;

Containers should be **evenly placed** inside the cell.

Correct container placement will permit free air circulation in the cell: avoid obstructing the air vents and overloading the equipment over the admissible limits.

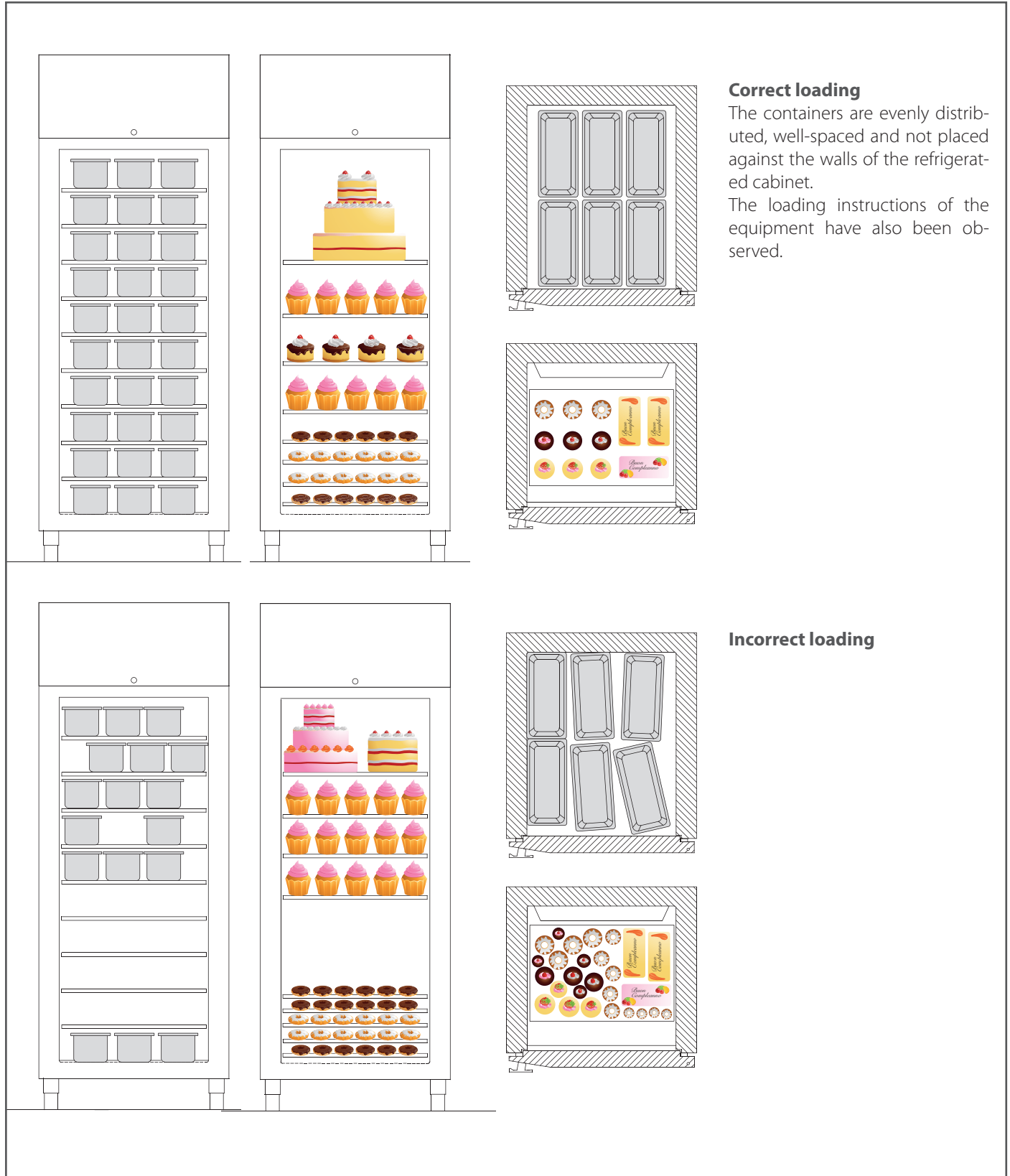

## Door lock

The door opening can be locked by acting on the lock placed on the dashboard.

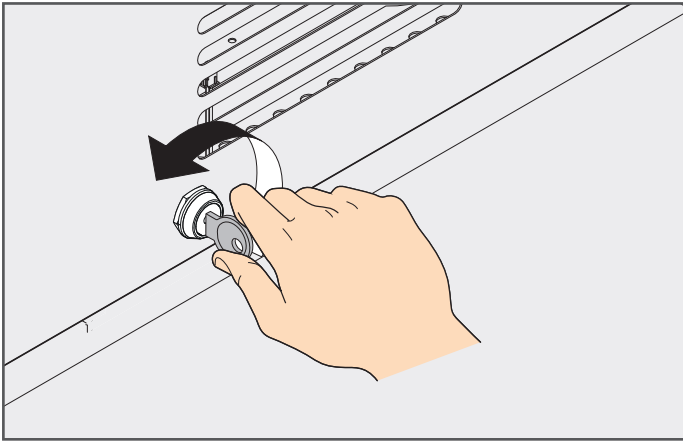

## Cloud Connection

If the customer has requested a Cloud subscription, the machine must be connected to the network via an Ethernet cable. The socket is located in the board located in the back of the dashboard.

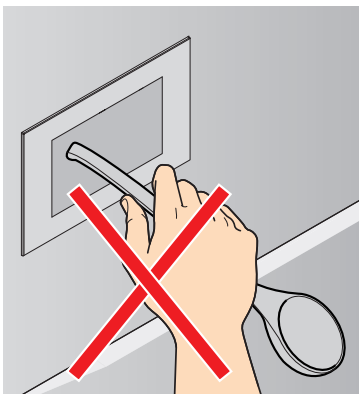
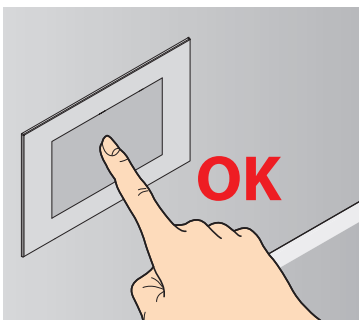
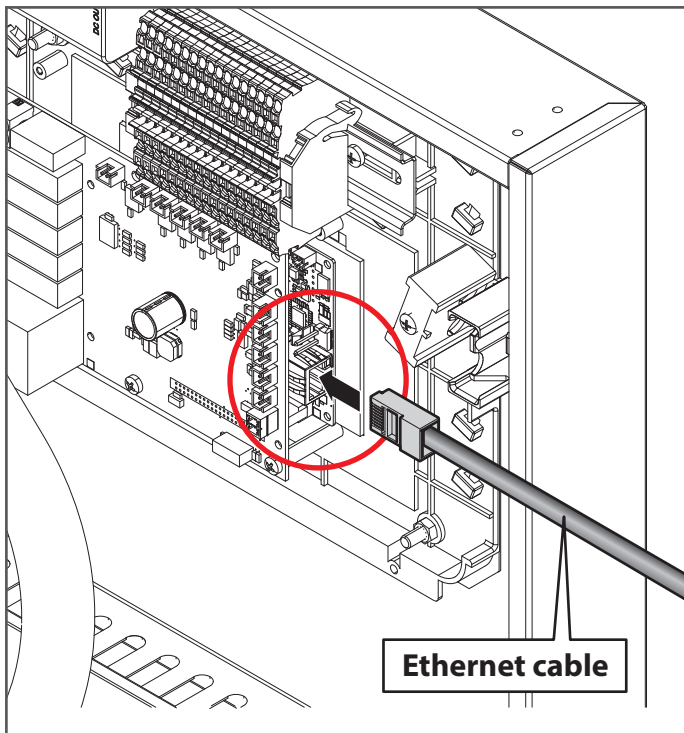

Do not touch the display with ladles and other objects, but only with your hands or any pens suitable for touch screens.

page 11

## Use menu

All you need to do to start using the machine is setting up:



the **temperature** inside the equipment;



the **humidity** inside the equipment;



the **rotation speed of the fans**.

page 16

## Constant cold

If enabled, the machine runs continuously (compressor always running). This function is useful when large quantities of food have to be loaded and, therefore, the door is opened often or for a long time.



Inactive function



Active function

## Warnings area

Provides information on the state of the machine.

If on, it indicates that:



The door is open



the machine is connected to the Cloud (if the customer has requested a subscription)



the fans are running



the compressor is running

the machine is in energy saving mode, i.e. it keeps a higher temperature compared to the set in case of limited work (e.g. at night). Parameters ES3 and ES4 determine the temperature set to be kept in case this condition occurs.



the machine is defrosting

page 17

## Settings menu

Allows you to make some settings on the machine and on the sets.



## Light

Turns on/off the LEDs in the dashboard or in the door.

page 12

## Recipes menu

Allows you to view the **list of the sets previously saved** by the user, the sets stored by the Manufacturer or to **create a new set**, assigning it a name and parameters according to your needs.

page 16

## Notifications menu

Displays any alarms that have occurred.

page 16

## Statistics menu

It provides information on:

- temperature changes;
- humidity changes in the last 12 hours.



Maximum temperature of use: 43°C

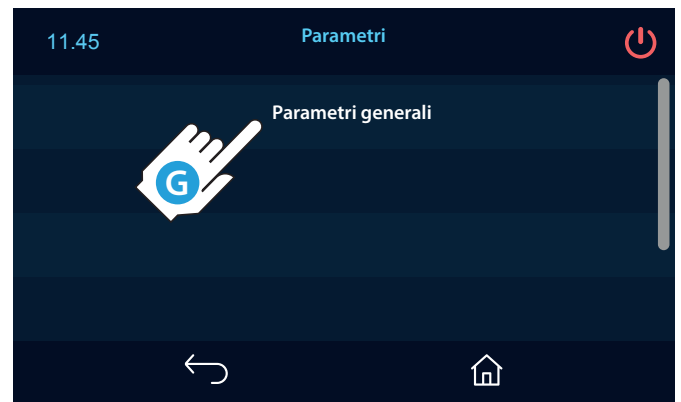
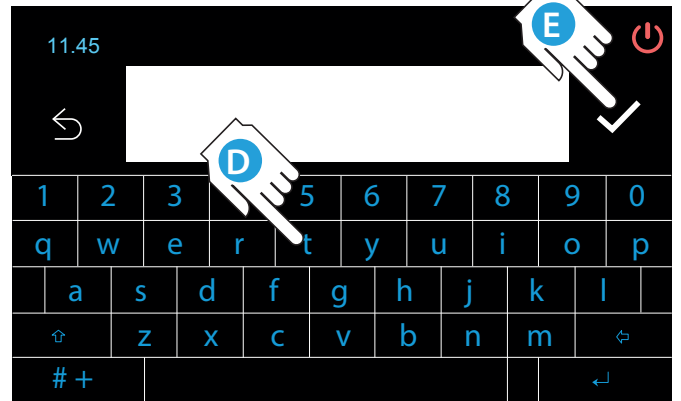
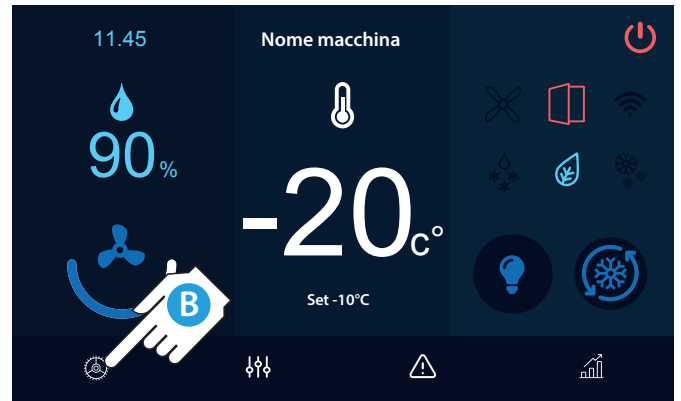

## First ignition







## Use menu

### Setting the operating parameters







All you need to do to start using the machine is setting up:

-  the **temperature** inside the equipment;
-  the **humidity** inside the equipment;
-  the **rotation speed of the fans**.

- A** Turn on the machine by touching the ON-OFF key.
- B** If you do not touch the display for a few minutes, the machine goes into stand-by mode: to exit this state, simply touch the display anywhere.
- C** To set the desired parameter:
  - C1** touch the field you want to set (e.g. "temperature");
  - C2** Use the keys  and  several times until the desired value is displayed;
  - C3** Confirm with  or cancel with .

**D** The screen displays:

**D1** the machine status icons:

-  The door is open
-  the machine is connected to the Cloud (if the customer has requested a subscription)
-  the fans are running
-  the compressor is running
-  the machine is in energy saving mode, i.e. it keeps a higher temperature compared to the set in case of limited work (e.g. at night). Parameters ES3 and ES4 determine the temperature set to be kept in case this condition occurs.
-  the machine is defrosting

- D2** Actual temperature and humidity in the cell
- D3** Fan speed

 During the operation of the machine it is always possible to change the parameters acting as for the setting.

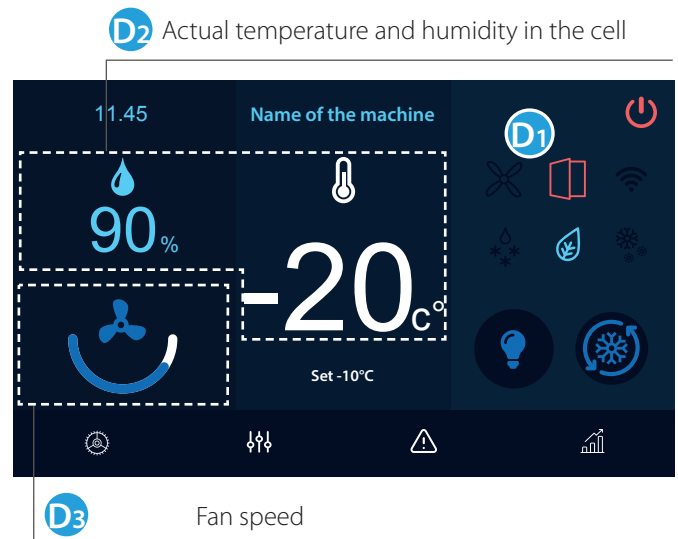







USE

## Recipes menu

### Saving a set



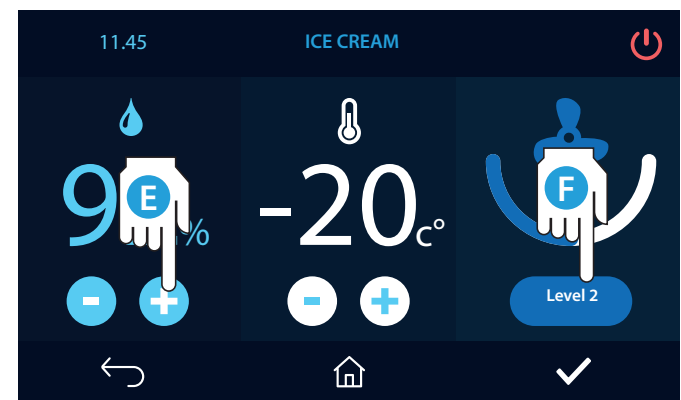
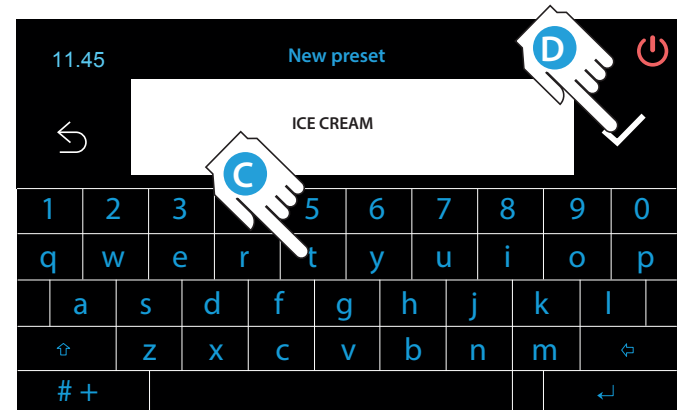
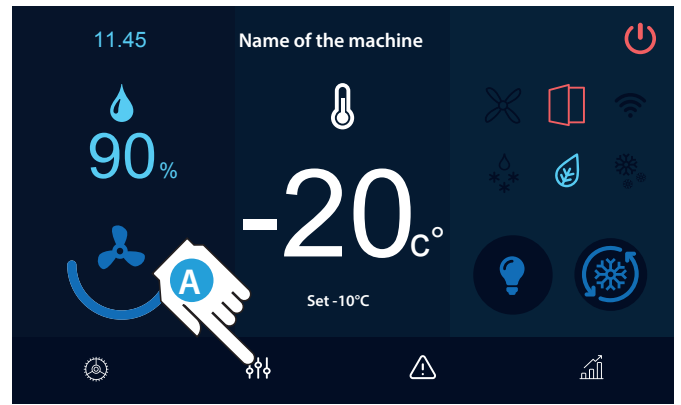

After setting the three parameters (temperature, humidity, fan speed) you can **save them**, assigning a name to the set just selected (e.g. ice cream); this allows you to reuse it without having to reset its parameters every time.

- A** Touch the "Recipes" field.
- B** Touch the key .
- C** Enter the name you wish to assign to the set (e.g. ice cream).
- D** Confirm with  or cancel with .
- E** A screen appears summarizing the parameters of the set; if necessary, you can **change them** by using the keys  and  as usual.
- F** Confirm by touching the  key



### Delete, change or duplicate a saved set

- A** Touch the "Recipes" field.
- B** Touch the name of the set you are interested in (e.g. "Chocolate"): several symbols appear allowing you to:

-  **Delete** the set.
-  **Edit** the three parameters of the set (temperature, humidity, fan speed) definitively.
-  **duplicate** the set;
-  **start** the set.

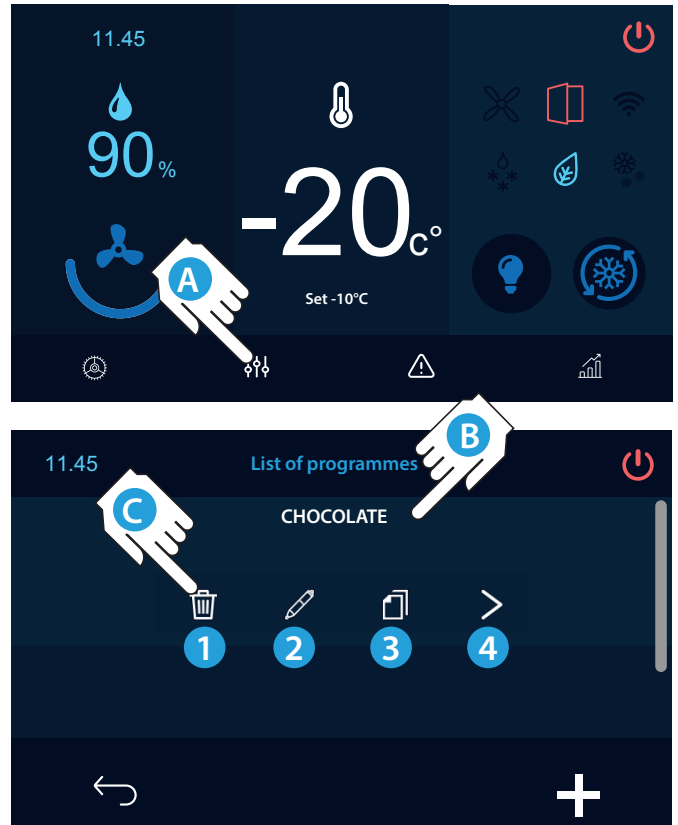

- C** Choose the desired option.

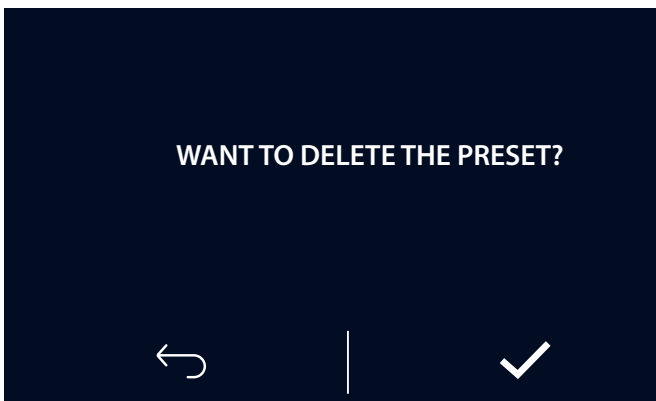

1





**Delete** the set: a pop-up asks for confirmation of deletion of the set.

Cancel the operation with  or confirm it with  (in this case it will no longer be possible to recover the deleted set).

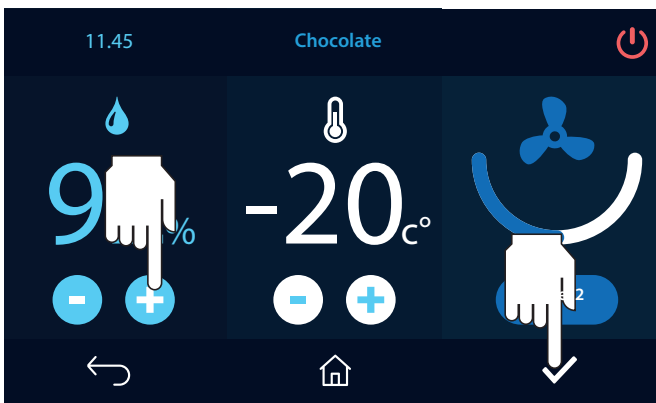
2



**edit** the three parameters of the set (temperature, humidity, fan speed) definitively, by using the keys  and  as usual.

Confirm by touching the  key

From now on the set will work with the new parameters set.

*Example:*

*Starting file:* chocolate -20°; 90%; v.1

*Files with changed parameters:* chocolate -20°; 95%; v.2



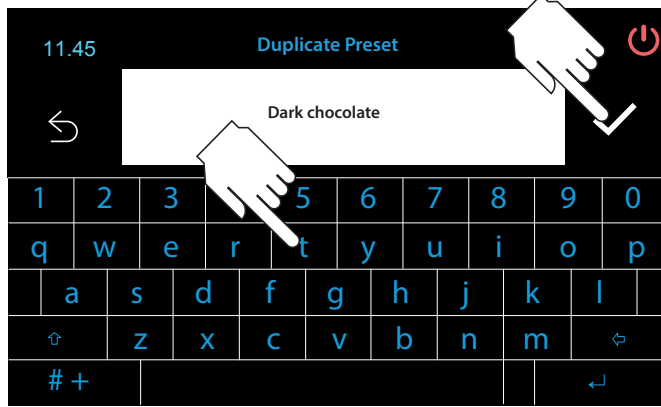

**Duplicate** the set (e.g. "Chocolate") making a copy to which you can assign any name ("Dark chocolate" for example).

At first, the copy has the same parameters as the original; these values can be changed by using the keys **-** and **+** as usual.

Confirm by touching the **✓** key

*Example:*

*Starting file:* chocolate -20°; 90%; v.1

*Duplicated copy file:* dark chocolate -20°; 95%; v.2

When duplicating a set, you need to change its name to prevent the source file from being overwritten.







### Start a set already saved by the user or the manufacturer

Cycles previously saved by the user or those stored by the Manufacturer can be found in the "Recipes" section.

To view all of them, touch the display and move your finger from right to left, always keeping the finger on it ("scroll" function).

To start a set that has already been saved:

- A** touch the "Recipes" field: a list of all previously saved sets appears (e.g. ice cream, chocolate, etc...).
- B** Touch the name of the set that suits your needs: different symbols appear.
- C** Start it using the key : A screen appears showing the name of the set in progress and the temperature inside the cabinet.
- C** During the operation of the machine, you can always change the parameters of the current set by touching the parameter you wish to change and acting, as usual, on the keys  and . Confirm using  or cancel using .

In this case, the "Set in progress" screen no longer displays the recipe that has been started and, therefore, the general "set" name appears instead of its name.

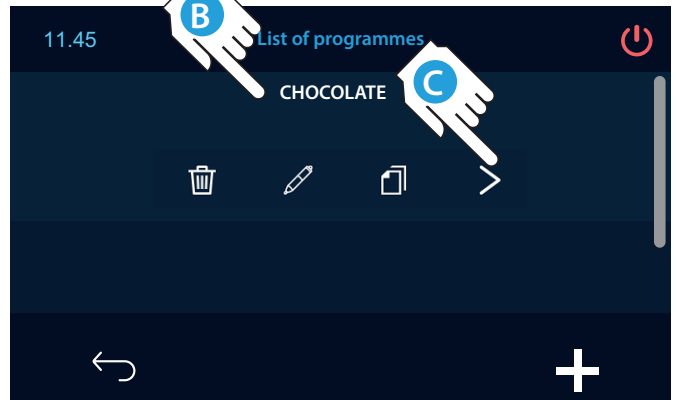

Actual temperature and humidity in the cell

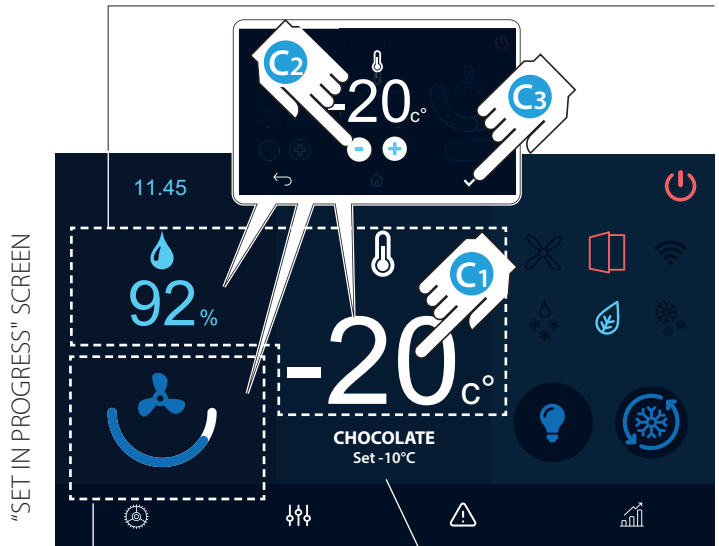

Fan speed

Name of the set started (e.g. chocolate) and its parameters (-20°C and 90%).  
If these parameters are changed (for example, I decrease the temperature to -18°C), the name "Chocolate" disappears to indicate that the set started is no longer in use.

## Statistics menu

The Statistics menu stores the changes in humidity and temperature over the last 12 hours. If necessary, you can download the data (text only) to a USB stick.

**A** Touch the "Statistics" field: a page appears providing information on the change in temperature and humidity during the day.

**B** Touch the desired symbol



Provides changes in temperature trend



Provides changes in humidity trend

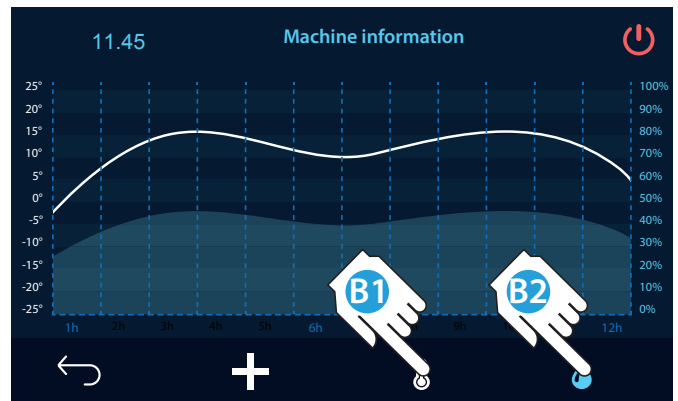
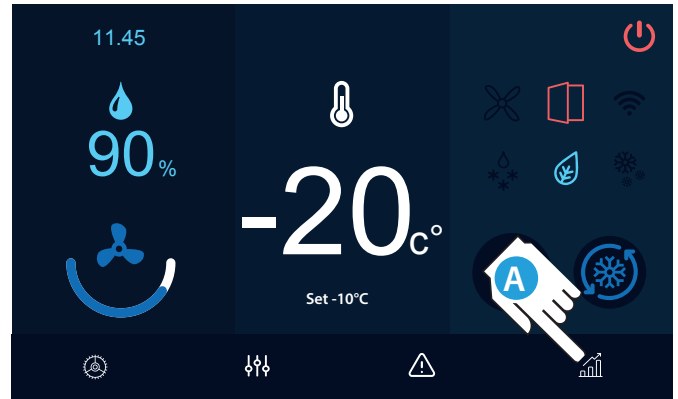

## Notifications menu

The screen provides a list of any alarms that have occurred.

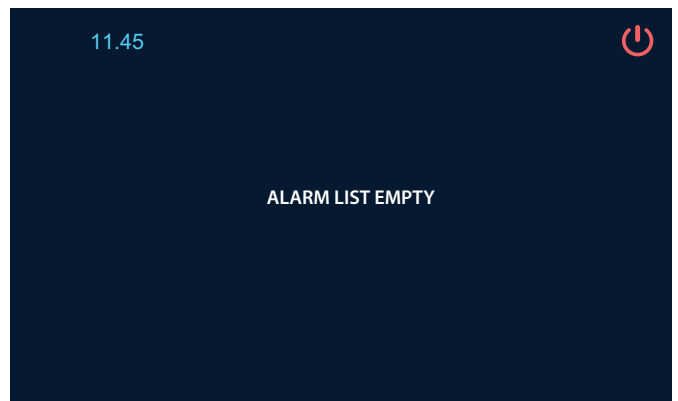

## Constant cold

If enabled, the machine runs continuously (compressor always running) for 30 minutes

This function is useful when large quantities of food have to be loaded and, therefore, the door is opened often or for a long time.

Inactive function

Active function

**A** Touch the "Constant cold" field.

**B** A screen appears with a downward time of 30 minutes. If necessary, the function can be blocked ahead of time by

pressing the key or the time can be restarted by pressing

the key.

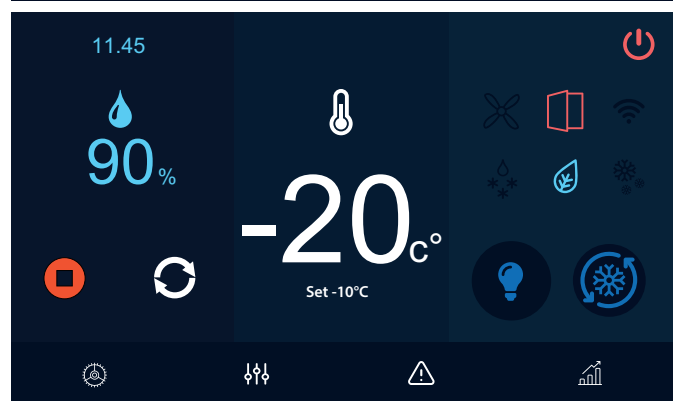
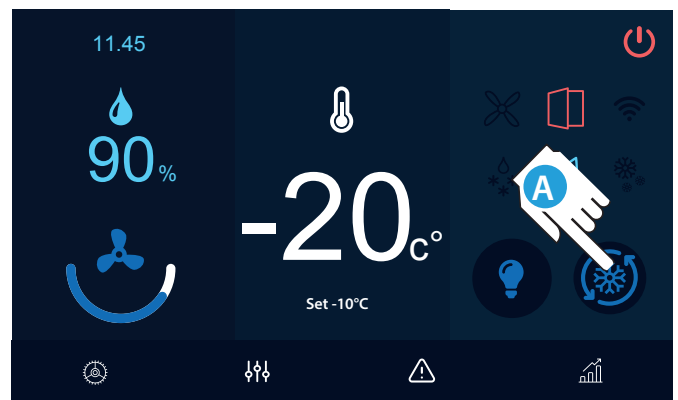

## Settings menu

**A** Touch the "Settings" field.

- B** A page appears allowing you to make some settings:
- **manual defrosting** (touching the entry immediately starts defrosting);
  - **date and time** setting;
  - language **selection**;
  - Assign a **name** to the machine;
  - Access the **menu for configuring** the machine parameters; the "Setting/service" menu is reserved for qualified personnel and, therefore, is protected by a password.

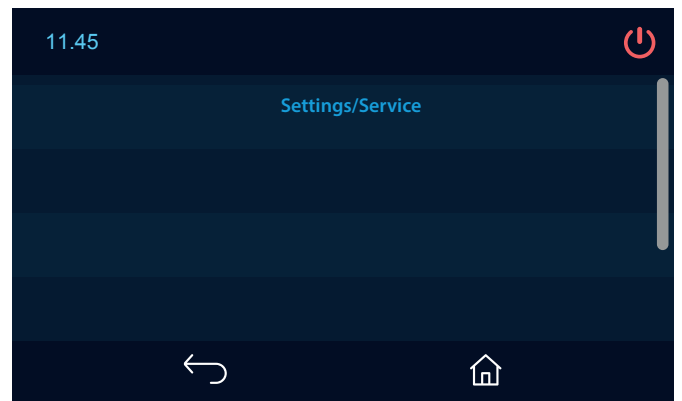
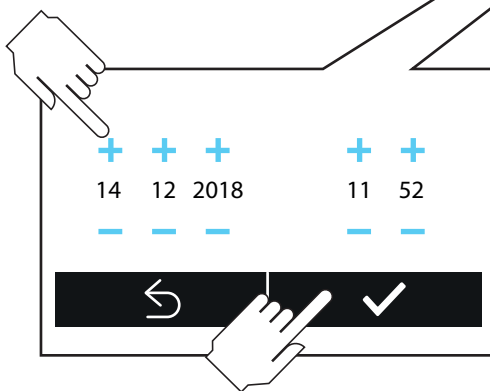
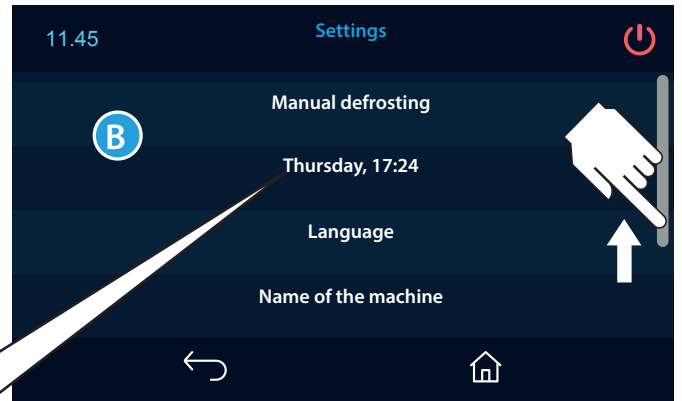
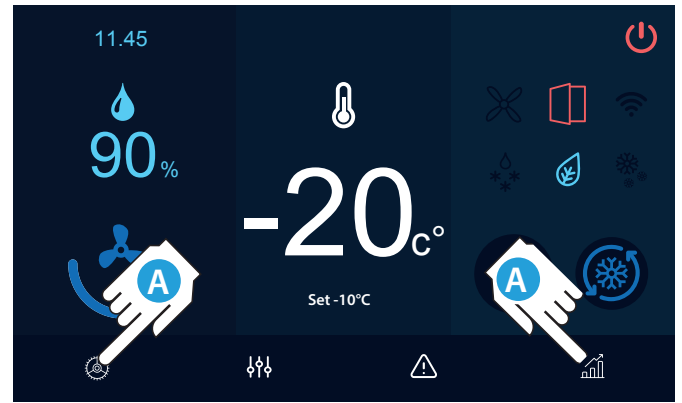

## Ordinary cleaning of the equipment



BEFORE PERFORMING ANY MAINTENANCE, CUT OFF THE POWER SUPPLY TO THE MACHINE AND WEAR SUITABLE PERSONAL PROTECTION EQUIPMENT (E.G. GLOVES, ETC.).



USERS MUST CARRY OUT ONLY ROUTINE MAINTENANCE OPERATIONS (I.E. CLEANING). FOR EXTRAORDINARY MAINTENANCE, CONTACT A SERVICE CENTRE AND ASK FOR THE ASSISTANCE OF AN AUTHORISED TECHNICIAN.



THE WARRANTY IS NULL AND VOID IN THE EVENT OF DAMAGES DUE TO NEGLIGENT OR INCORRECT MAINTENANCE (E.G. USE OF UNSUITABLE DETERGENTS).



BEWARE OF HOT BODIES WHEN PERFORMING MAINTENANCE AND CLEANING ON THE ENGINE.



BEWARE OF SHARP EDGES ON SLOTTED CONVEYORS, ON THE CONDENSER COIL (THE FINS ARE PROTECTED BY A FILTER), ON THE MOTOR SUPPORT BASE (HOLES) AND ON THE SLOTS IN THE DASHBOARD.

To clean any component or accessory, DO NOT use:

- abrasive or powder detergents;
- aggressive or corrosive detergents (e.g. hydrochloric/muriatic or sulphuric acid, caustic soda, etc.). Attention! Do not use these substances to clean the floor underneath the appliance;
- abrasive or sharp tools (e.g. abrasive sponges, scrapers, steel brushes, etc.);
- steamed or pressurised water jets.

At first use wash the trays and chamber using a cloth dampened with hot soapy water and end with rinsing and drying. To remove processing waste, run the equipment off-load for approximately 30 minutes.

### External steel surface cleaning

Use a cloth dampened with hot soapy water or specific products for steel. End with rinsing and drying.

### Equipment chamber cleaning

Daily clean the equipment chamber to maintain high levels of hygiene and equipment performance.

Always use a cloth dampened with hot soapy water and end with rinsing and drying.

Personal protective equipment to be worn during routine maintenance of the equipment

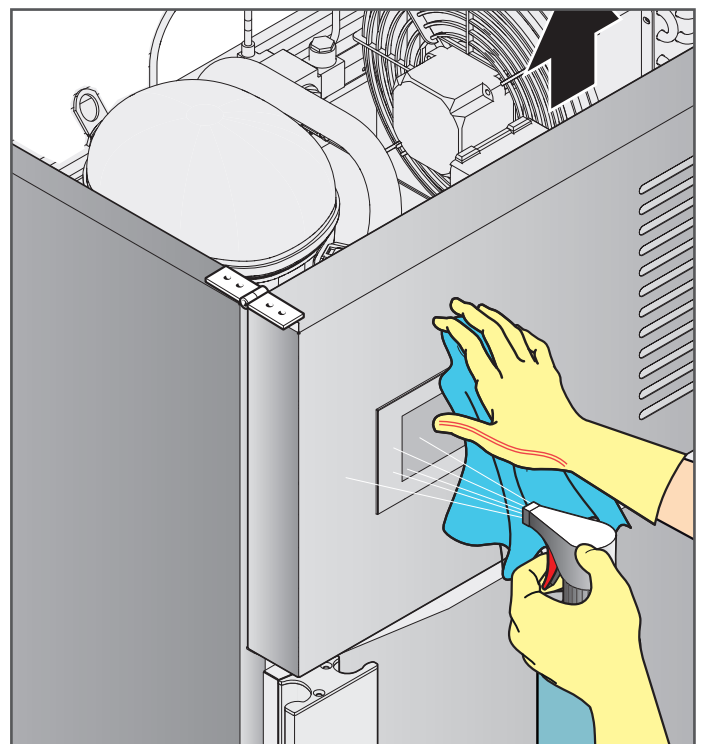
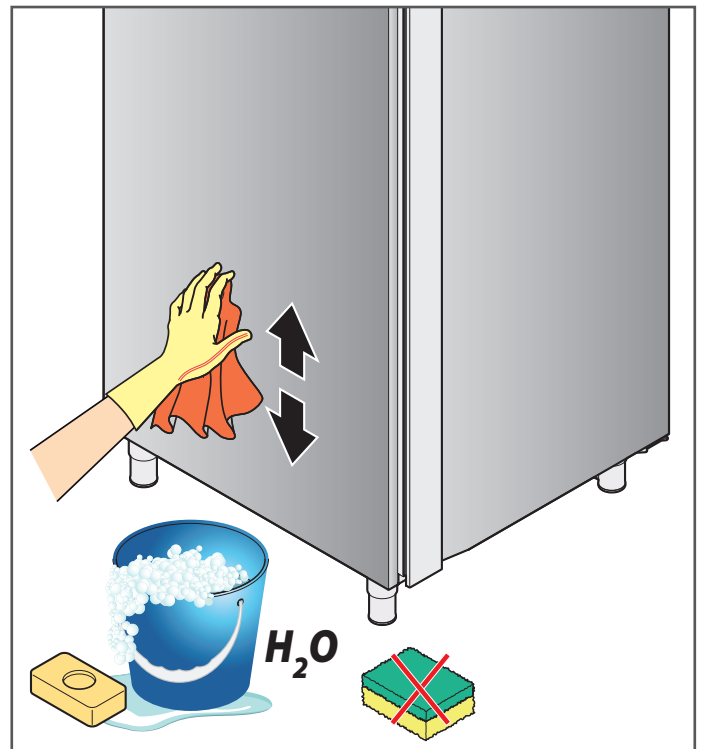

## Touch screen cleaning

Use a cloth just soaked in a specific product for the crystals following the instructions of the manufacturer of the detergent. Do not spray too much product to avoid infiltrations that could damage the display.

## Slot and grill/sponge cleaning

Keep vents free of obstructions and dust cleaning them often with a normal vacuum or brush.

Periodically it is recommended to lift the front panel by removing the screws below and vacuum the dust accumulated on the condenser fan. Lifting the panel also gives access to the condensation water collection tray between the condenser and the compressor. Inside it, there is a "GM" metal grill that acts as a sponge and absorbs water, increases the exchange surface and facilitates the evaporation of condensation water; this "grill/sponge" must be regularly removed and cleaned with soap and water or in the dishwasher.

## Filter cleaning

On the right side of the condenser there is a "FL" filter held in place by two metal clips. Periodically remove it and wash it with soap and water. After waiting for it to dry completely, put it back in place. Do not use the machine without a filter.

## Disuse

During periods of inactivity, disconnect the power and water supply (if any). Protect external steel equipment parts wiping them down with a soft cloth slightly dampened with Vaseline oil. Leave the door ajar to guarantee correct ventilation.

Before resuming operations:

- accurately clean the equipment and accessories;
- reconnect the equipment to the power and water mains (if any);
- inspect the equipment before using it;
- restart the equipment for at least 60 minutes without any food inside.

 **To ensure that the device is in perfect use and safety conditions, we recommend you have it maintained and serviced by an authorised service centre at least once a year.**

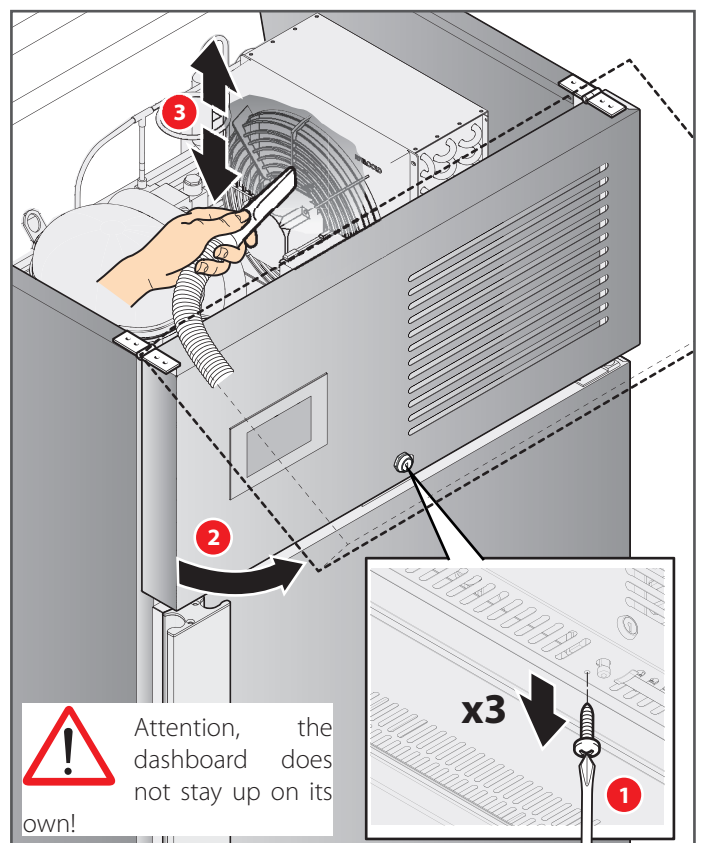
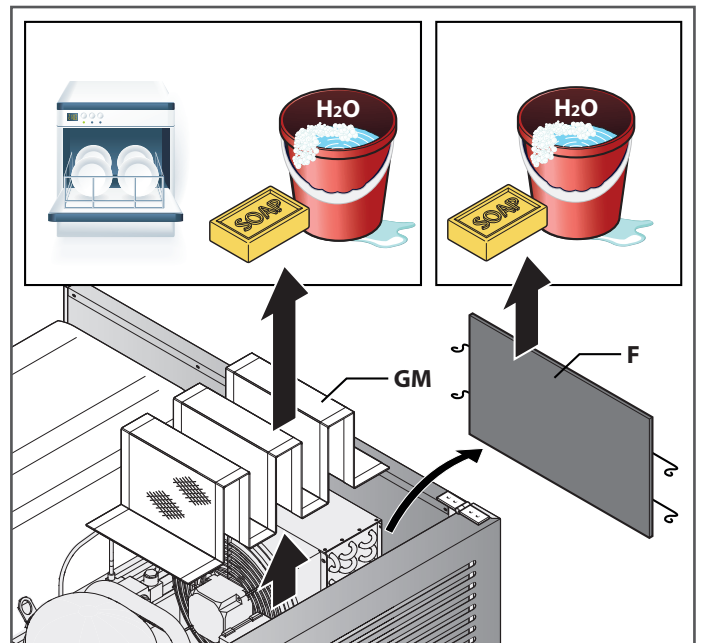
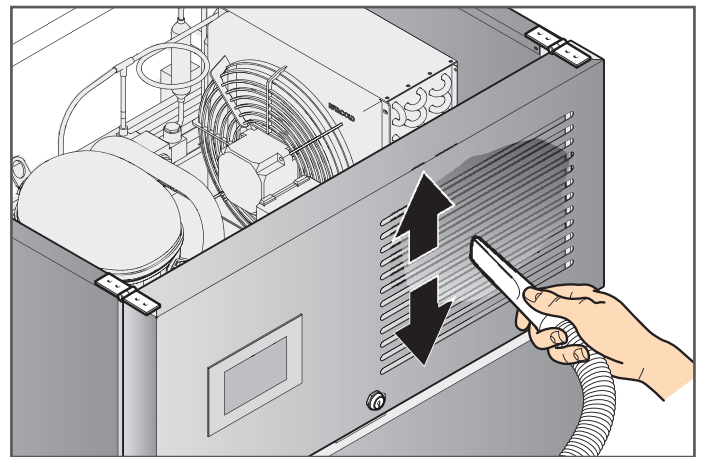

## Disposal at end working life

Only qualified personnel can disconnect the machine from the electrical and water mains.

If applicable, recovery and correctly dispose:

- coolant gas;
- anti-freeze solutions in the hydraulic circuits, avoiding spills or disposal in the environment.

As per Legislative Decree no. 49 art. 13 dated 2014 "Implementation of WEEE Directive 2012/19/EU on electric and electronic waste"



The barred bin marking specifies that the product was released onto the market after August 13, 2015 and should not be assimilated with other waste at the end of its working life but disposed of separately.

All equipment is made of recyclable metallic materials (stainless steel, iron, aluminium, galvanised sheet metal, copper, etc-) in percentages over 90% in weight.

Put the equipment out of order for disposal removing the power cord and any compartment or chamber lock devices (where applicable).

Pay attention to managing this product at the end of its working life, reducing negative impacts on the environment and improving resource use efficiency, applying the "who pollutes pays", prevention, reuse, recycling and recovery preparation principles.

Please remember that illicit or incorrect product disposal is punishable by law.

### Information on disposal in Italy

WEEE equipment in Italy must be delivered to:

- Collection centres (also called ecological islands or platforms)
- the dealer where new equipment is purchased who must withdraw it free of charge ("one to one" withdrawal);

### Information on disposal in European Union countries

The Community Directive on WEEE equipment was assimilated in different ways in each country. Therefore we suggest you contact your local authorities or Dealer to request the correct disposal method.



Awaiting dismantling and disposal, the equipment can be temporarily stored even outdoors, provided the electrical, refrigeration and hydraulic circuits are integral and closed. Also make sure that the doors cannot be closed to prevent entrapment. Follow the environmental protection laws in the user's country.

## Malfunctions

If the equipment does not work or functional or structural alterations are noted:

- disconnect it from the power and water mains;
- consult the table below to check the proposed solutions;

If the solution is not found in the table, contact a manufacturer's authorised service centre communicating:

- the nature of the defect;
- the equipment code and serial number found on its specification plate.

Require original spare parts for repairs: the manufacturer cannot be held liable and null and voids the warranty in the event non original spare parts are used.



To ensure that the appliance is in perfect use and safety conditions, we recommend you have it maintained and serviced by an authorised service centre at least once a year.

1		2		3		4		5		6		7		8		9		10		11		12		13		14		15		16		17	
MARCHIO - SERIE NR. - SERIAL NO. - NO. OE SERIE - رقم التسلسل		CODICE - KODE - CODE - RÉFÉRENCE PRODUIT - رمز		MIDELLO TYPE - MODÈLE - MODEL - النوع		TENSIONE - TENSIE - TENSION - الجهد الكهربائي		CORRENTE ASSorbita - CURRENT - CURRENT - التيار الكهربائي		POTENza - POWER - PUISSANCE - القدرة		POTENza - POWER - PUISSANCE - القدرة		POTENza - POWER - PUISSANCE - القدرة		POTENza - POWER - PUISSANCE - القدرة		POTENza - POWER - PUISSANCE - القدرة		POTENza - POWER - PUISSANCE - القدرة		POTENza - POWER - PUISSANCE - القدرة		POTENza - POWER - PUISSANCE - القدرة		POTENza - POWER - PUISSANCE - القدرة		POTENza - POWER - PUISSANCE - القدرة		POTENza - POWER - PUISSANCE - القدرة		POTENza - POWER - PUISSANCE - القدرة	

- 1 Manufacturer
- 2 Serial number
- 3 Code
- 4 Model
- 5 Voltage
- 6 Current absorbed during operation
- 8 Power of the defrosting resistance
- 9 Power of the defrosting resistance
- 10 Rated power of other resistances
- 11 Lamp power
- 12 Maximum and minimum pressure
- 13 Coolant, type and quantity
- 15 Gas expanding in the insulation
- 16 Year of manufacture
- 17 Climate class (#)

Problem type	Before contacting a service centre, check that...
The device is fully off.	- ...the system is powered and the plug is not disconnected.
The equipment does not cool enough	- ...it is not effected by an external heat source; - ...the doors are fully shut; - ...the condenser filter is not clogged; - ...the front air vents are not obstructed by objects or dust; - ...food is well distributed in the cell and do not obstruct ventilation in the cell; - ...the equipment is not overloaded with food (follow your equipment load instructions).
The equipment is very noisy	- ... there are no contacts between the equipment and any other object or machine; - ...the equipment is perfectly levelled; - ...visible screws are well-tightened.



Do not attempt to repair the equipment on your own. This could cause serious damages to humans, animals and property and null and voids the Warranty. Always request service by a service centre authorised by the manufacturer and request ORIGINAL spare parts.



## Warranty

The manufacturer's warranty on the equipment and its parts regarding its production is for 1 year, from invoice date, and consists in the free supply of parts to be replaced which, at its sole discretion, are defective.

The manufacturer will take care to remove any faults and defects provided that the equipment has been installed and used correctly in accordance with the instructions given in the manual. The warranty does not cover damage caused by limescale deposits, over-voltage or tampering by unauthorized or unqualified persons.

Consumables such as glass, aesthetic parts, gaskets, lamps and other parts consumed during use are not covered by the warranty.

Labour, travel or missions, part transport and any other expenses for equipment to be replaced are at the purchaser's expense during the warranty period.

Material replaced under the warranty remain our property and must be returned at the purchaser's expense.

# MANUALE DI UTILIZZO E MANUTENZIONE

## PASTICCERIA NC81N

[Art. 474600400604]



## **Complimenti per aver acquistato la nostra apparecchiatura!**

Il lavoro è più semplice grazie alla grafica intuitiva dell'interfaccia utente, pensata per semplificare l'accesso alle funzioni, che sono rappresentate per essere subito individuate e per favorire l'interazione tra l'utente e il dispositivo. In un'unica macchina un concentrato di tecnologia che le consentirà di svolgere attività diverse e complementari per la migliore efficienza in cucina.

Il presente manuale ha lo scopo di fornire tutte le informazioni necessarie per utilizzare correttamente l'apparecchiatura e per effettuare un'adeguata manutenzione.

Prima di ogni operazione bisogna leggere attentamente le istruzioni contenute, in quanto forniscono indispensabili indicazioni riguardanti lo stato di sicurezza delle apparecchiature.



Il costruttore declina ogni responsabilità da usi non previsti del prodotto. Lingua di stesura originale: italiano. Il costruttore non si ritiene responsabile di eventuali errori di trascrizione o traduzione. E' vietata la riproduzione, anche in parte, del presente manuale.



## Avvertenze di sicurezza per l'utilizzo

- Un utilizzo ed una pulizia diversi da quelli indicati e previsti in questo libretto sono considerati impropri e possono provocare danni, lesioni o incidenti mortali, fanno decadere la garanzia e sollevano il costruttore da qualsiasi responsabilità.
- Prima dell'uso dell'apparecchiatura leggere attentamente il presente libretto e conservarlo con cura per ogni ulteriore consultazione futura da parte dei vari operatori.
- In caso di cessione dell'apparecchiatura far avere al nuovo utilizzatore questo libretto.
- L'utilizzo è riservato solamente a personale idoneo e addestrato, sottoposto a corsi di formazione periodici.
- Non avvicinarsi alle parti elettriche con mani bagnate oppure scalzi.
- E' assolutamente vietato manomettere od asportare i dispositivi di sicurezza adottati (griglie di protezione, adesivi di pericolo, ecc...). Il costruttore declina ogni responsabilità se non vengono rispettate le istruzioni suddette.
- Non inserire cacciaviti od altro tra le protezioni (protezioni ventilatori, evaporatori, ecc.).
- Per una buona funzionalità del gruppo compressore ed evaporatore non ostruire mai le apposite prese d'aria.
- In caso di incendio non usare acqua, premunirsi di estintore a CO<sub>2</sub> (anidride carbonica) e raffreddare nel più breve tempo possibile la zona del vano motore.

## Impiego corretto dell'apparecchiatura

- Questa apparecchiatura è considerata macchina agroalimentare (Regolamento CE n° 1935/2004), destinata al trattamento dei prodotti alimentari nelle cucine industriali e professionali. Non è idonea alla conservazione di prodotti farmaceutici, chimici o qualsiasi altro prodotto non alimentare.
- Allo scopo di ottenere le migliori prestazioni dell'apparecchiatura è necessario rispettare le seguenti indicazioni:
  - Non introdurre all'interno dell'apparecchiatura cibi caldi o liquidi scoperti, animali vivi, oggetti vari o prodotti corrosivi.
  - Confezionare o proteggere in altro modo gli alimenti soprattutto se contengono aromi o spezie.
  - Sistemare le derrate all'interno dell'apparecchiatura in modo da non limitare la circolazione dell'aria, evitando di disporre sulle griglie carte, cartoni, taglieri ecc., che possono ostacolare il passaggio dell'aria.
  - Evitare il più possibile frequenti e prolungate aperture della/delle porta/e.
  - Se la porta è stata aperta, attendere alcuni istanti prima di riapirla.
  - Disporre gradualmente gli alimenti partendo dal basso verso l'alto; viceversa togliere gli alimenti partendo dall'alto verso il basso.
- Le apparecchiature frigorifere sono state realizzate e progettate con gli opportuni accorgimenti al fine di garantire la sicurezza e la salute dell'utilizzatore e non presentano spigoli pericolosi, superfici affilate o elementi sporgenti dagli ingombri. La loro stabilità è garantita anche a porte aperte, è vietato comunque appendersi alle porte.
- La non osservanza di queste norme può provocare danni e lesioni anche mortali e fa decadere la garanzia.

## In caso di malfunzionamento dell'apparecchiatura...

- Se l'apparecchiatura non funziona o si notano alterazioni funzionali o strutturali, disconnetterla dall'alimentazione elettrica e idrica e contattare un centro di assistenza autorizzato dal costruttore senza tentarla di ripararla da se. Si raccomanda l'impiego di ricambi originali. Il costruttore declina ogni responsabilità per l'impiego di ricambi non originali.
- Si consiglia, per assicurarsi che l'apparecchio si trovi in condizioni di utilizzo e sicurezza perfette, di sottoporlo almeno una volta all'anno a manutenzione e controllo da parte di un centro di assistenza autorizzato.



### Rischi collegati all'utilizzo dell'apparecchiatura

- RISCHI DOVUTI AGLI SPOSTAMENTI SU RUOTE: se l'apparecchiatura monta delle ruote, fare attenzione, durante gli spostamenti, a non spingere violentemente l'apparecchiatura per evitare che si ribalti e si danneggi, fare attenzione anche alle eventuali asperità della superficie di scorrimento. L'apparecchiatura dotata di ruote non può essere livellata, quindi fare attenzione che la superficie di appoggio sia perfettamente orizzontale e piana. Bloccare sempre le ruote con gli appositi fermi.
- RISCHI DOVUTI AL RIBALTAMENTO: l'armadio, una volta posizionato, deve essere bloccato con apposite staffe in quanto il peso della porta tende a sbilanciarlo verso la parte frontale con rischi di ribaltamento. Se l'armadio è posizionato su ruote non è possibile ancorarlo e quindi si raccomanda la **massima attenzione** nell'apertura della porta specialmente se l'apparecchiatura è vuota.
- RISCHI DOVUTI AD ELEMENTI MOBILI: l'unico elemento mobile presente è il ventilatore, ma non presenta alcun rischio in quanto è protetto da griglia di protezione fissata tramite viti.
- RISCHI DOVUTI ALLE BASSE/ELEVATE TEMPERATURE: in prossimità delle zone con pericolo di temperature basse/elevate, sono stati apposti degli adesivi indicanti "PERICOLO TEMPERATURA".
- RISCHI DOVUTI ALL'ENERGIA ELETTRICA: i rischi di natura elettrica sono stati risolti progettando gli impianti elettrici secondo la norma CEI EN 60335-1. Appositi adesivi indicanti "alta tensione" individuano le zone con pericoli di natura elettrica.
- Livelli di rumorosità inferiore ai 70 dB.
- Prestare attenzione a non schiacciarsi le dita chiudendo la porta.
- Quando la porta è aperta, il cruscotto sporge rispetto all'ingombro della macchina; per questo motivo prestare attenzione a non sbattere la testa.
- La maniglia sporge dall'ingombro della macchina; prestare attenzione a possibili urti.

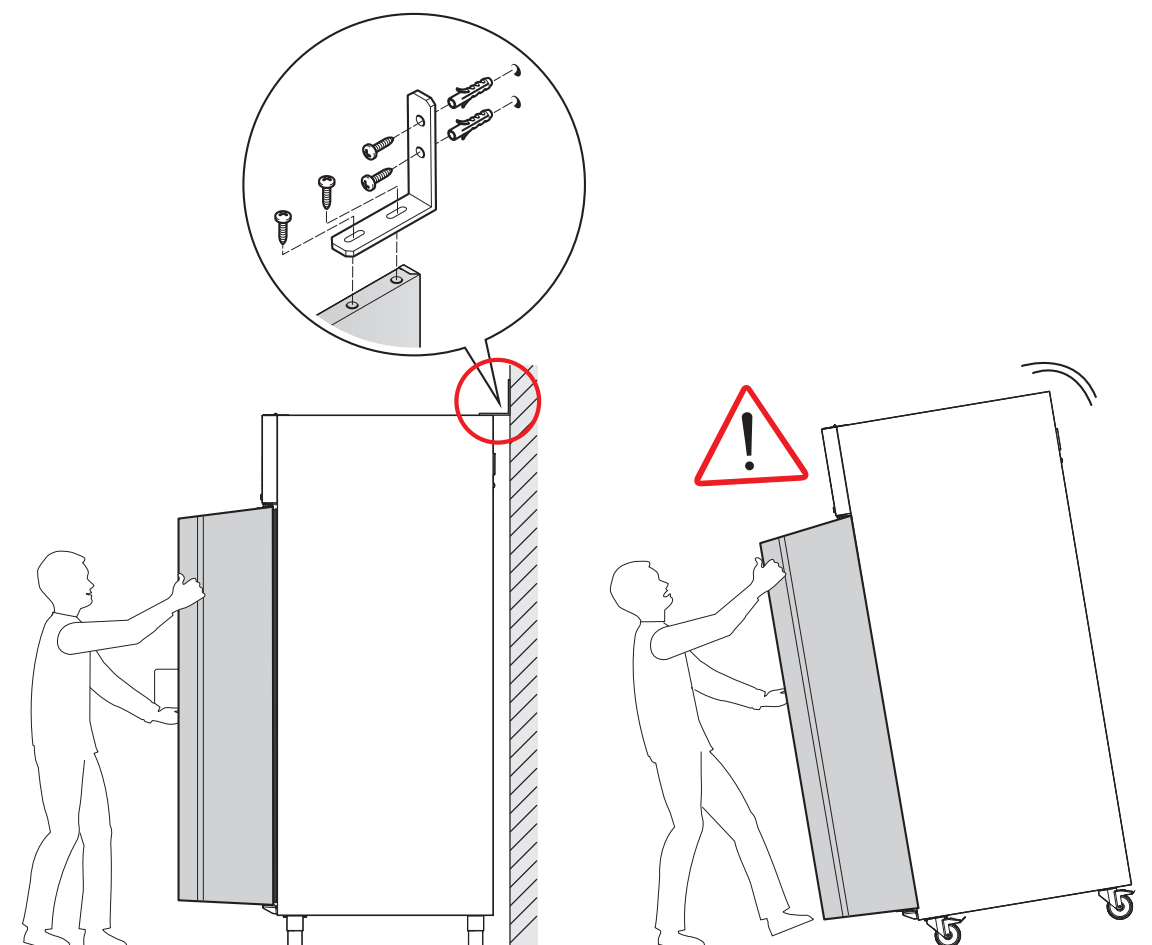

## Caricare correttamente l'apparecchiatura

Le pietanze vanno sistemate, in unico strato, in recipienti:

- scoperti;
- adatti all'uso alimentare;
- resistenti alle basse temperature;

I recipienti dovranno essere sistemati in **modo omogeneo e uniforme all'interno** della cella.

Un corretto posizionamento dei contenitori permetterà la libera circolazione dell'aria all'interno della cella: evitare di ostruire le ventole di aerazione e di sovraccaricare l'apparecchiatura oltre i limiti consentiti.

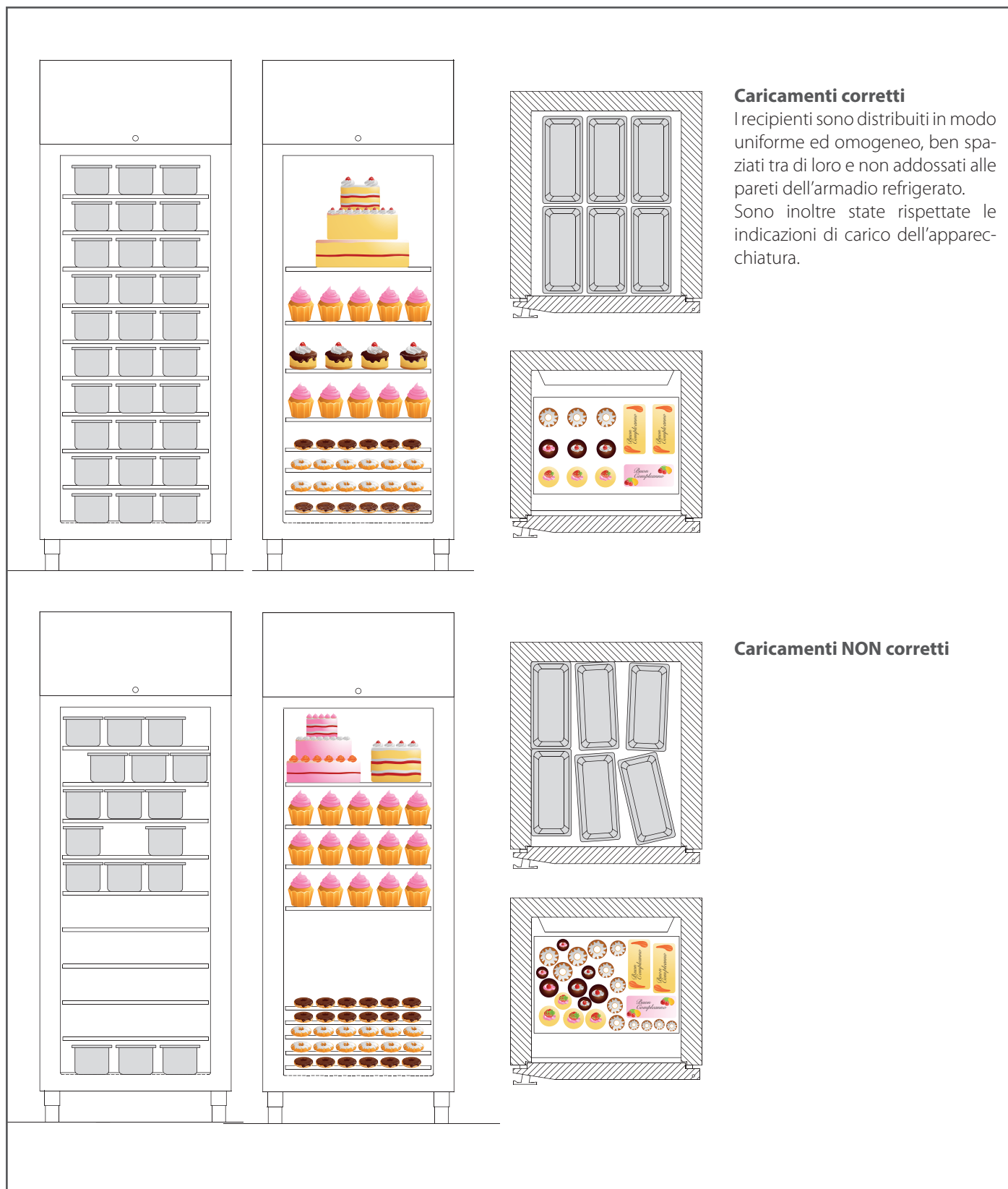

### Caricamenti corretti

I recipienti sono distribuiti in modo uniforme ed omogeneo, ben spazati tra di loro e non addossati alle pareti dell'armadio refrigerato. Sono inoltre state rispettate le indicazioni di carico dell'apparecchiatura.

### Caricamenti NON corretti

## Blocco della porta

L'apertura della porta può essere bloccata agendo sulla serratura posta sul cruscotto.

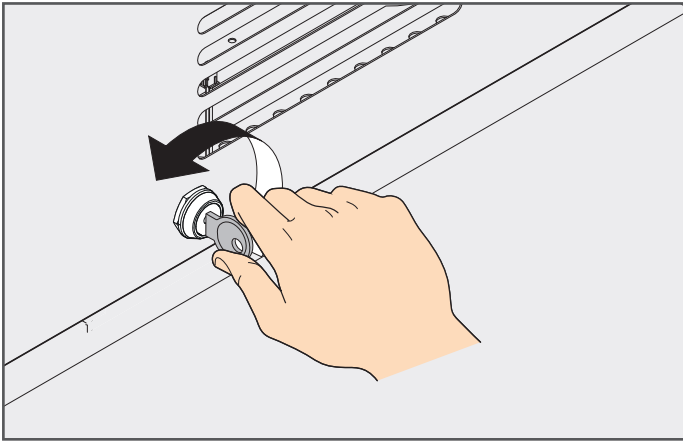

## Connessione Cloud

Se il cliente ha richiesto un abbonamento Cloud, la macchina deve venire connessa alla rete mediante un cavetto ethernet. La presa si trova nella scheda posizionata nella parte posteriore del cruscotto.

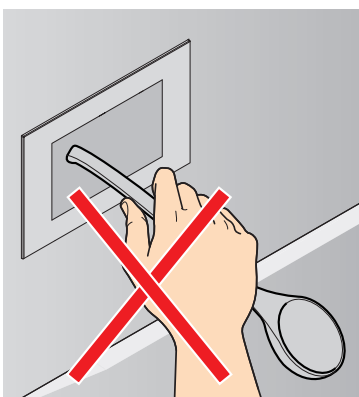
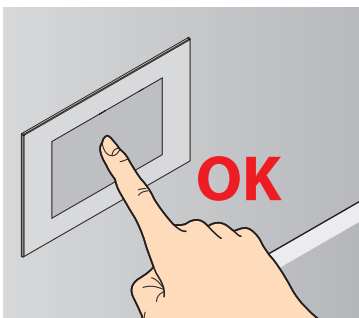
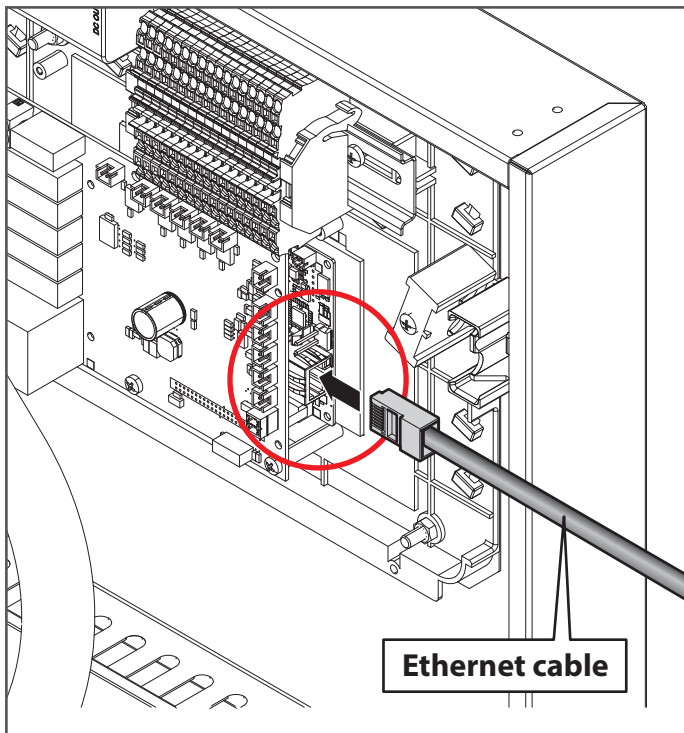

Si raccomanda di non toccare il display con mestoli e altri oggetti, ma solo con le mani o eventuali penne idonee a schermi Touch Screen

pag. 11

## Menu utilizzo

Per utilizzare la macchina serve solo impostare:



la **temperatura** all'interno dell'apparecchiatura;



l'**umidità** all'interno dell'apparecchiatura;



la **velocità di rotazione delle ventole**.

pag. 16

## Freddo continuo

Se attivato, la macchina funziona di continuo (compressore sempre in funzione). La funzione risulta utile quando si devono caricare grosse quantità di alimenti e quindi la porta viene aperta spesso o a lungo.



funzione non attiva



funzione attiva

## Area avvisi

Forniscono delle indicazioni sullo stato della macchina.

Se acceso indica che:



la porta è aperta



la macchina è connessa al Cloud (se il cliente ha richiesto un abbonamento)



le ventole sono in funzione



il compressore è in funzione

la macchina è in risparmio energetico, cioè mantiene una temperatura maggiore rispetto al set, nei momenti di poco lavoro (ad es. di notte). I parametri ES3 ed ES4 stabiliscono il set di temperatura da tenere nel caso si verificasse la condizione



la macchina è in fase di sbrinamento

pag. 17

## Menu impostazioni

Permette di effettuare alcune impostazioni sulla macchina e sui set.

pag. 12

## Menu Ricette

Permette di visualizzare la **lista dei set salvati in precedenza** dall'utilizzatore, i set memorizzati dal Costruttore o di **creare un nuovo set**, assegnandogli un nome e dei parametri in base alle proprie esigenze.

pag. 16

## Menu notifiche

Visualizza eventuali allarmi intercorsi.

pag. 16

## Menu statistiche

Fornisce delle informazioni su:

- variazioni della temperatura;
- variazioni dell'umidità durante le ultime 12 ore.



## Luce

Accende/spegne i LEDs presenti nel cruscotto o nella porta.



Temperatura massima di utilizzo : 43°C



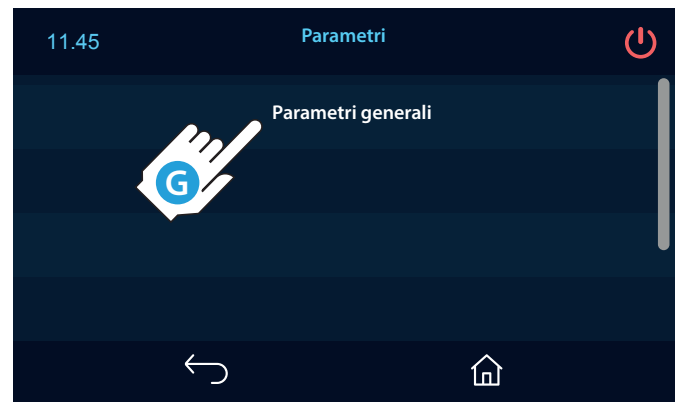
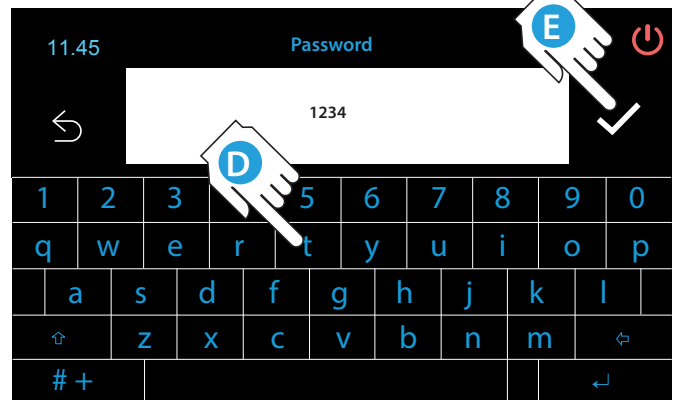
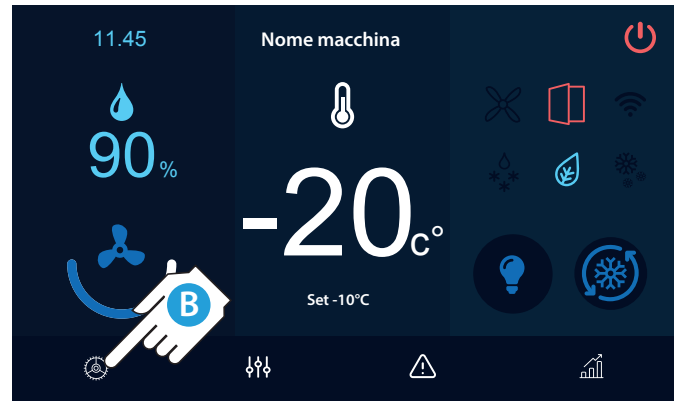

## Prima accensione







## Menu utilizzo

### Impostare i parametri di funzionamento

Per utilizzare la macchina serve solo impostare:

-  la **temperatura** all'interno dell'apparecchiatura;
-  l'**umidità** all'interno dell'apparecchiatura;
-  la **velocità di rotazione delle ventole**.

- A** Accendere la macchina toccando il tasto ON-OFF.
- B** Se non si tocca il display per qualche minuto la macchina va in stand-by; per uscire da questo stato è sufficiente toccare il display in un punto qualunque.
- C** Per impostare il parametro che interessa:
  - C1** toccare il campo che si intende impostare (ad esempio "temperatura");
  - C2** agire sui tasti  e  più volte fino a visualizzare a display il valore desiderato;
  - C3** confermare con  o annullare con .
- D** Nella schermata che appare sono visualizzate:

**D1** le icone di stato macchina:

-  la porta è aperta
-  la macchina è connessa al Cloud (se il cliente ha richiesto un abbonamento)
-  le ventole sono in funzione
-  il compressore è in funzione
-  la macchina è in risparmio energetico, cioè mantiene una temperatura maggiore rispetto al set, nei momenti di poco lavoro (ad es. di notte). I parametri ES3 ed ES4 stabiliscono il set di temperatura da tenere nel caso si verificasse la condizione
-  la macchina è in fase di sbrinamento

- D2** Temperatura e umidità effettive in cella
- D3** Velocità ventole

 Durante il funzionamento della macchina è sempre possibile modificare i parametri agendo come fatto per l'impostazione.

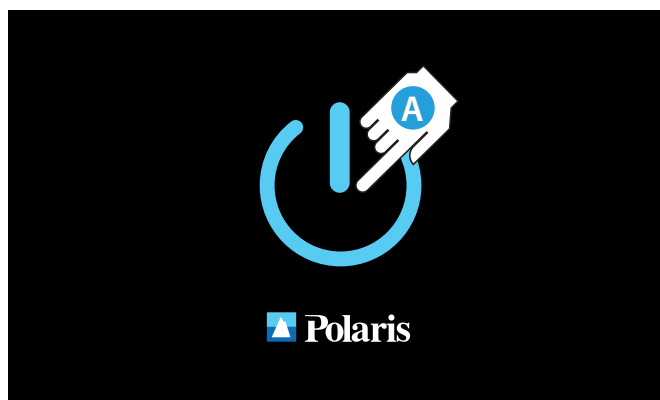

**D2** Temperatura e umidità effettive in cella

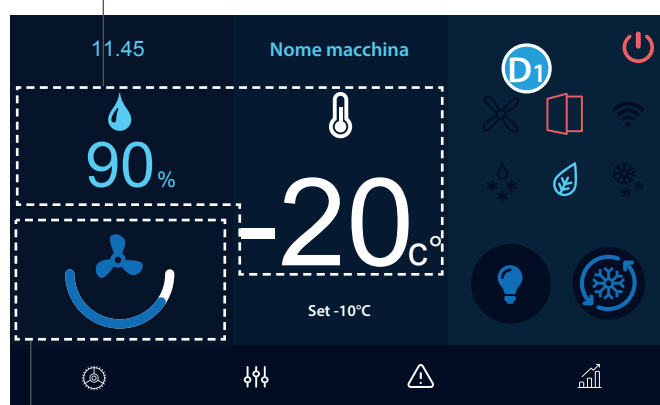







**D3** Velocità ventole

## Menu ricette

### Salvare un set impostato



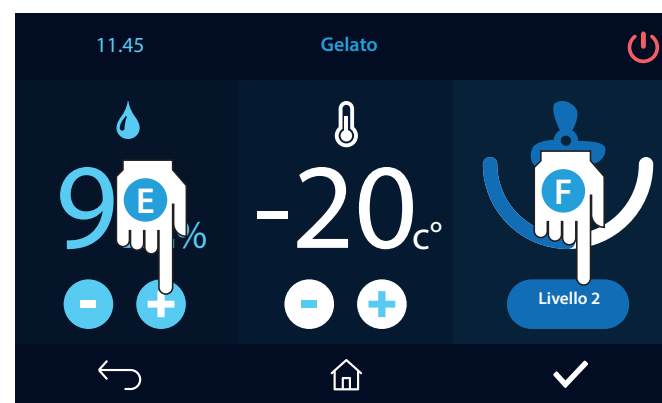
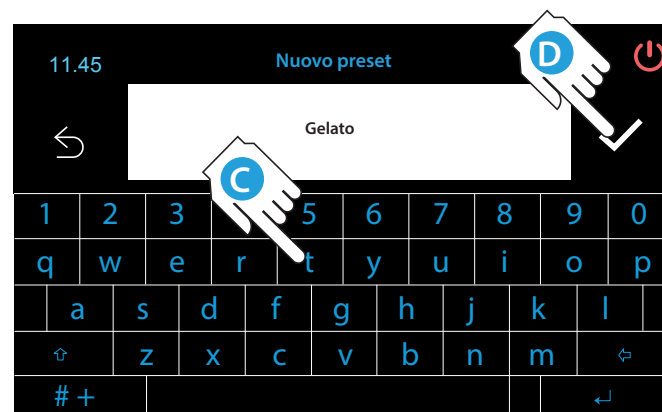

Dopo aver impostato i tre parametri (temperatura, umidità, velocità ventole) è possibile **salvarli**, assegnando un nome al set appena impostato (es. gelato); questo permette di poterlo riutilizzare senza bisogno di reimpostare ogni volta i suoi parametri.

- A** Toccare il campo "Ricette".
- B** Toccare il tasto .
- C** Digitare il nome che si intende assegnare al set (es. gelato).
- D** Confermare con  o annullare con .
- E** Appare una schermata che riassume i parametri del set; se necessario è possibile **modificarli** agendo, come di consueto, sui tasti  e .
- F** Confermare toccando il tasto .



## Eliminare, variare o duplicare un set salvato

- A** Toccare il campo "Ricette".
- B** Toccare il nome del set che interessa (es. "Cioccolato"): appaiono diversi simboli che permettono di:

-  **eliminare** il set;
-  **modificare** in modo permanente i tre parametri del set (temperatura, umidità, velocità ventole);
-  **duplicare** il set;
-  **avviare** il set.

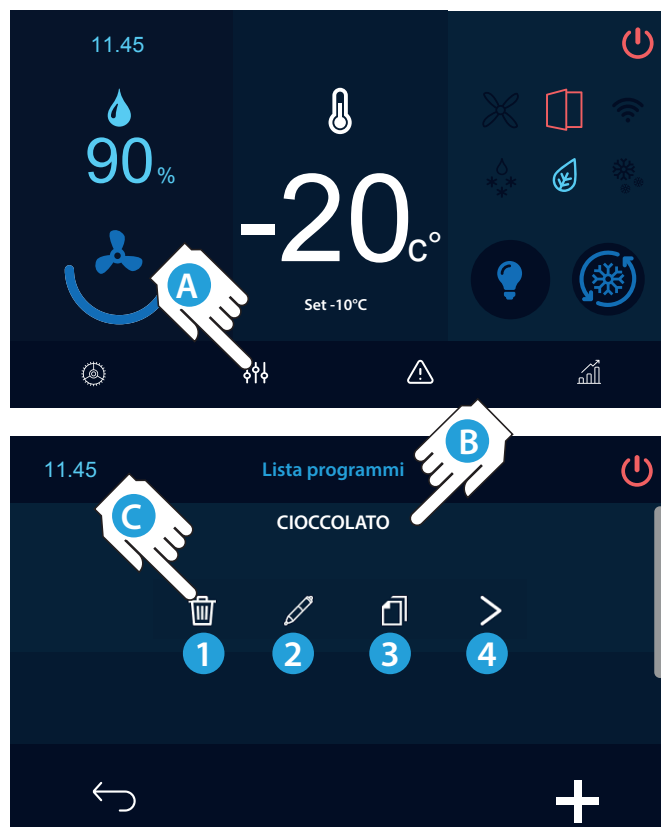

- C** Scegliere l'opzione che interessa.

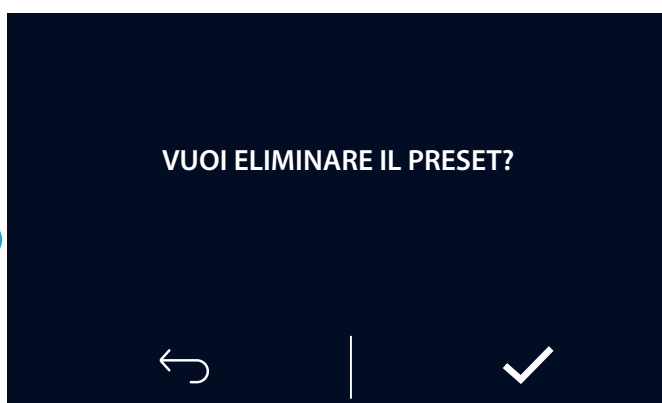

1



**Elimina** il set: un pop-up chiede conferma di cancellazione del set.

Annullare l'operazione con  o confermarla con  (in questo caso non sarà più possibile recuperare il set cancellato).

2



**Modifica** in modo permanente i tre parametri del set (temperatura, umidità, velocità ventole) agendo, come di consueto, sui tasti  e .

Confermare toccando il tasto .

Da questo momento il set funzionerà con i nuovi parametri impostati.

*Esempio:*

*File di partenza:* cioccolato -20°; 90%; v.1

*File con parametri variati:* cioccolato -20°; 95%; v.2

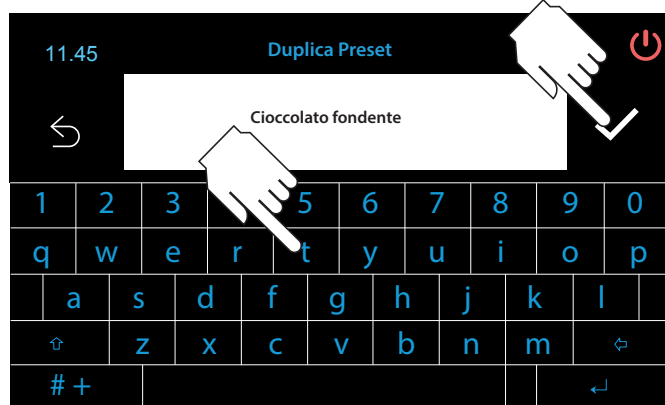

**Duplica** il set (es. "Cioccolato") facendo una copia alla quale è possibile assegnare un nome a piacere (es. "Cioccolato fondente").

La copia, inizialmente, ha gli stessi parametri dell'originale; questi valori possono essere variati agendo, come di consueto, sui tasti **-** e **+**.

Confermare toccando il tasto **✓**.

*Esempio:*

*File di partenza:* cioccolato -20°; 90%; v.1

*File copia duplicato:* cioccolato fondente -20°; 95%; v.2

Quando si duplica un set è necessario cambiare il suo nome per evitare che il file di partenza venga sovrascritto.







## Avviare un set già salvato dall'utilizzatore o dal Costruttore

I cicli salvati in precedenza dall'utilizzatore o quelli memorizzati dal Costruttore si trovano nella sezione "Ricette".

Per visualizzarli tutti, toccare il display e spostare il dito dal basso verso l'alto tenendolo sempre appoggiato (funzione "scroll").

Per avviare un set già salvato:

- A** Toccare il campo "Ricette": compare la lista di tutti i set salvati in precedenza (es. gelato, cioccolato, ecc..).
- B** Toccare il nome del set che soddisfa le proprie esigenze: appaiono diversi simboli.
- C** Avviarlo con il tasto : appare una schermata che indica il nome del set in corso e la temperatura all'interno dell'armadio.
- C** Durante il funzionamento della macchina è sempre possibile modificare i parametri del set in corso toccando il parametro che si intende variare e agendo, come di consueto, sui tasti  e . Confermare con  o annullare con .

In questo caso nella schermata "Set in corso" non è più attiva la ricetta avviata e quindi non compare più il suo nome ma genericamente "set".

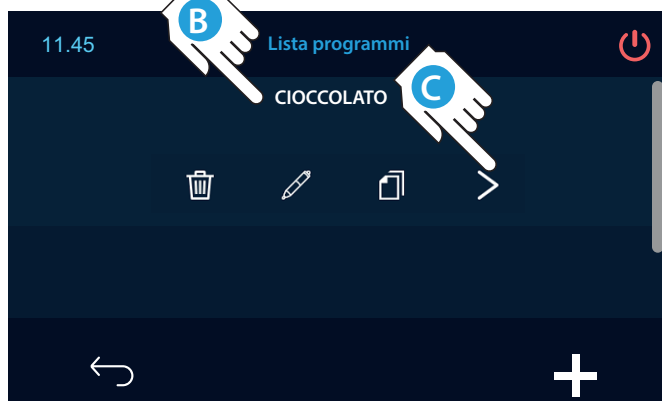

Temperatura e umidità effettive in cella

SCHERMATA "SET IN CORSO"

Velocità ventole

Nome set avviato (es. cioccolato) e parametri che lo caratterizzano (-20°C e 90%). Se questi parametri vengono variati (ad esempio alzo la temperatura a -18°C) il nome "Cioccolato" scompare ad indicare che non è più attivo il set avviato.

## Menu statistiche

Il menu statistiche tiene in memoria le variazioni di umidità e temperatura delle ultime 12 ore. Se necessario è possibile scaricare i dati (solo testo) in una chiavetta USB.

**A** Toccare il campo "Statistiche": compare una pagina che fornisce informazioni sulla variazione della temperatura e dell'umidità durante la giornata.

**B** Toccare il simbolo che interessa



fornisce variazioni sull'andamento della temperatura



fornisce variazioni sull'andamento dell'umidità

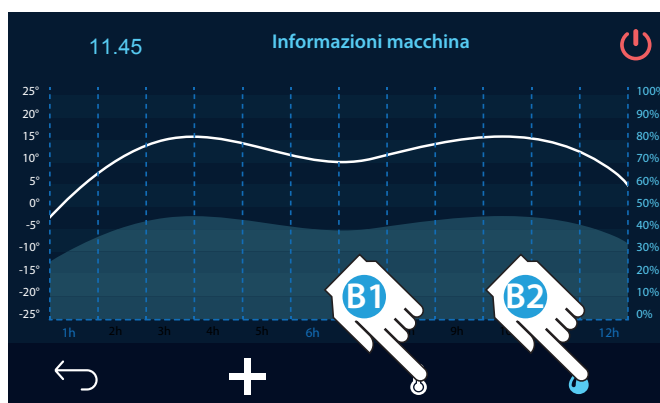

## Menu notifiche

La schermata fornisce la lista di eventuali allarmi intercorsi.

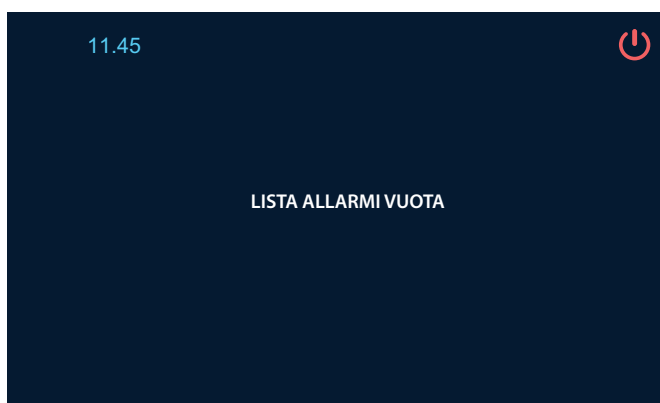

## Freddo continuo

Se attivato, la macchina funziona di continuo (compressore sempre in funzione) per un tempo di 30 minuti.

La funzione risulta utile quando si devono caricare grosse quantità di alimenti e quindi la porta viene aperta spesso o a lungo.



funzione non attiva



funzione attiva

**A** Toccare il campo "Freddo continuo".

**B** Appare una schermata con un tempo a scalare di 30 minuti. Se necessario è possibile bloccare anzitempo la funzione

premendo il tasto  oppure riavviare da capo il tempo con il tasto .

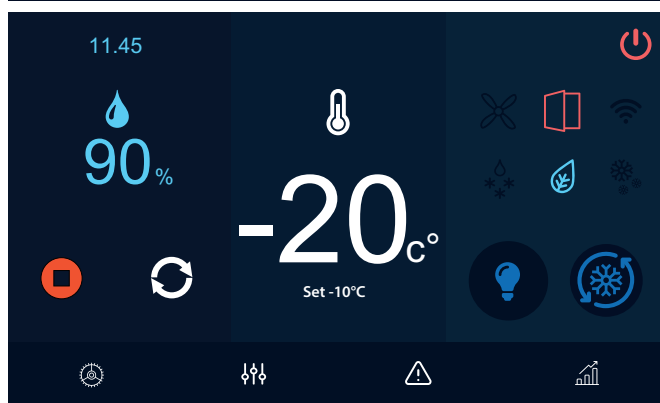

## Menu impostazioni

- A** Toccare il campo "Impostazioni".
- B** Compilare una pagina che permette di effettuare alcune impostazioni:
- **sbrinamento manuale** (toccando la voce parte immediatamente lo sbrinamento);
  - **impostazione** data e ora;
  - selezione **lingua**;
  - assegnare un **nome** alla macchina;
  - accesso al **menu di configurazione** dei parametri macchina; il menu "Setting/service" è riservato a personale qualificato e quindi è coperto da password.

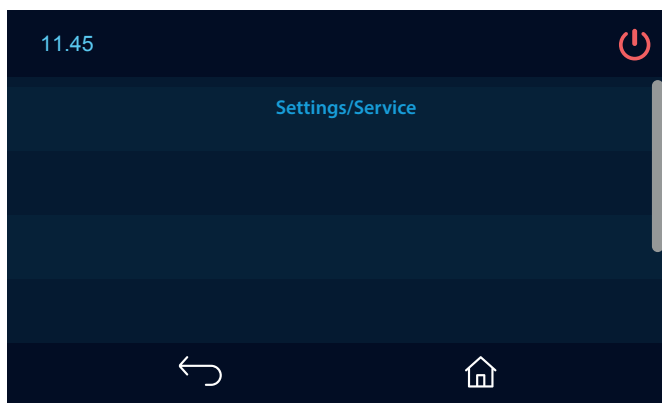
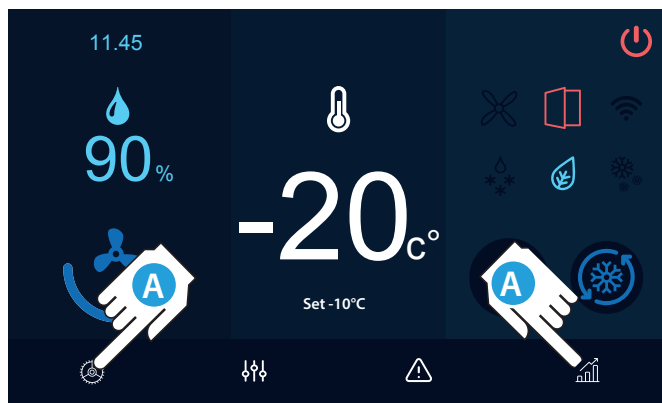
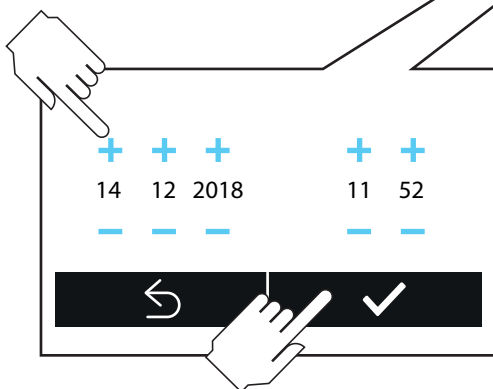



UTILIZZO



## Pulizia ordinaria dell'apparecchiatura

 PRIMA DI EFFETTUARE QUALSIASI INTERVENTO DI MANUTENZIONE ORDINARIA O STRAORDINARIA, È NECESSARIO DISINSERIRE L'ALIMENTAZIONE ELETTRICA DELL'APPARECCHIO ED INDOSSARE ADEGUATI STRUMENTI DI PROTEZIONE PERSONALE (ES. GUANTI, ECC...).

 L'UTILIZZATORE DEVE EFFETTUARE LE SOLE OPERAZIONI DI MANUTENZIONE ORDINARIA (INTESA COME PULIZIA). PER LA MANUTENZIONE STRAORDINARIA CONTATTARE UN CENTRO DI ASSISTENZA RICHIEDENDO L'INTERVENTO DI UN TECNICO AUTORIZZATO.

 LA GARANZIA DECADE IN CASO DI DANNI PROVOCATI DA MANCATA O ERRATA MANUTENZIONE (ES. UTILIZZO DI DETERGENTI NON ADATTI).

 ATTENZIONE AI CORPI CALDI QUANDO DI ESEGUE LA MANUTENZIONE E LA PULIZIA SUL MOTORE

 ATTENZIONE BORDI TAGLIANTI SUI CONVOGLIATORI ASOLATI, SULLA BATTERIA CONDENSANTE (LE ALETTE SONO PROTETTE DA FILTRO), SULLA BASE SUPPORTO MOTORE (FORATURE) E SULLE ASOLATURE DEL CRUSCOTTO.

Per la pulizia di qualsiasi componente o accessorio NON utilizzare:

- detersivi abrasivi o in polvere;
- detersivi aggressivi o corrosivi (es. acido cloridrico/muriatico o solforico, soda caustica, ecc...). Attenzione! Non usare tali sostanze nemmeno per pulire il pavimento sotto l'apparecchiatura;
- utensili abrasivi o appuntiti (es. spugne abrasive, raschietti, spazzole in acciaio, ecc...);
- getti d'acqua a vapore o a pressione.

Al primo utilizzo lavare le teglie e la camera utilizzando un panno imbevuto di acqua calda saponata e terminare con un risciacquo e un'asciugatura. Per eliminare i residui di lavorazione, far funzionare a vuoto l'apparecchiatura per circa 30 minuti.

## Pulizia superfici in acciaio esterne

Utilizzare un panno imbevuto di acqua calda saponata o prodotti specifici per l'acciaio. Terminare con un risciacquo e un'asciugatura.

## Pulizia camera apparecchiatura

Pulire quotidianamente la camera dell'apparecchiatura per mantenere livelli elevati di igienicità e le prestazioni dell'apparecchiatura.

Per la pulizia utilizzare un panno imbevuto di acqua calda saponata e terminare con un risciacquo e un'asciugatura.

DPI (dispositivi di protezione personale) da indossare durante la manutenzione ordinaria dell'apparecchiatura

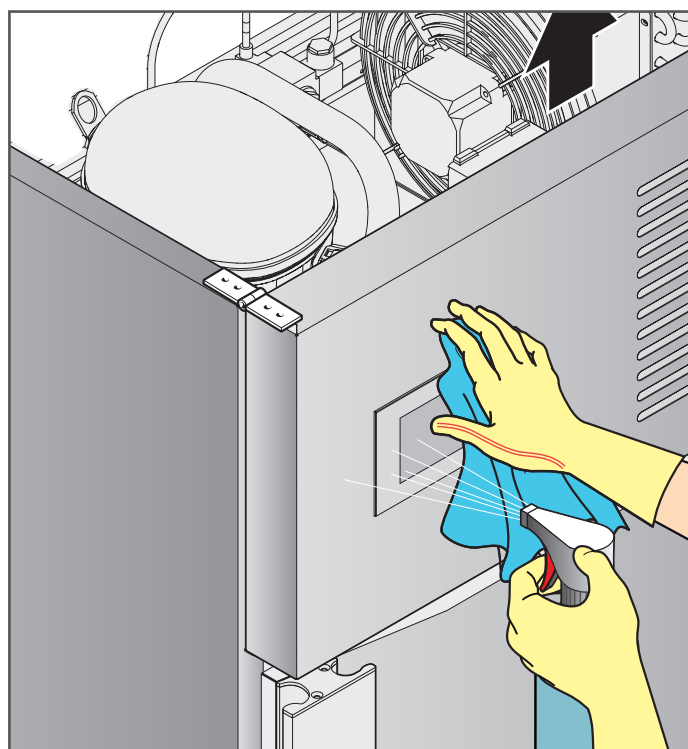
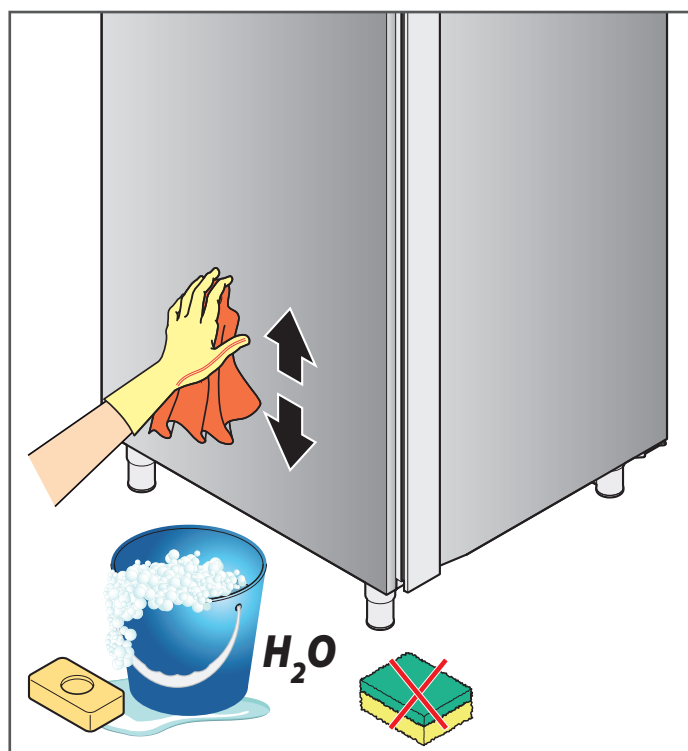

## Pulizia Touch screen

Utilizzare un panno appena imbevuto di un prodotto specifico per i cristalli seguendo le indicazioni del produttore del detergente.

Non spruzzare troppo prodotto per evitare infiltrazioni che potrebbero danneggiare il display.

## Pulizia feritoie e griglia/spugna

Tenere le feritoie libere da ostruzioni e polvere pulendole spesso con un normale aspirapolvere o un pennello.

Periodicamente si consiglia di sollevare il pannello frontale rimuovendo le viti sottostanti e aspirare la polvere accumulata sulla ventola del condensatore. Sollevando il pannello si ha anche accesso alla vaschetta di raccolta dell'acqua di condensa che si trova tra il condensatore e il compressore. All'interno di essa, c'è una griglia metallica "GM" che funge da spugna e assorbendo l'acqua, aumenta la superficie di scambio e facilita l'evaporazione dell'acqua di condensa; questa "griglia/spugna" deve essere regolarmente estratta e pulita con acqua e sapone oppure in lavastoviglie.

## Pulizia filtro

Sul lato destro del condensatore si trova un filtro "FL" tenuto in posizione da due mollette metalliche. Periodicamente rimuoverlo e lavarlo con acqua e sapone. Dopo aver atteso la sua completa asciugatura rimetterlo in posizione. Non utilizzare la macchina senza filtro montato.

## Periodi di inattività

Durante i periodi di inattività, staccare l'alimentazione elettrica ed idrica (se presente). Proteggere le parti esterne in acciaio dell'apparecchiatura passandole con un panno morbido appena imbevuto con olio di vaselina.

Lasciare la porta socchiusa in modo da garantire un corretto ricambio d'aria.

Al ripristino, prima dell'utilizzo:

- effettuare un'accurata pulizia dell'apparecchiatura e degli accessori;
- ricollegare l'apparecchiatura all'alimentazione elettrica ed idrica (se presente);
- sottoporre l'apparecchiatura a controllo prima di riutilizzarla;
- riavviare l'apparecchiatura per almeno 60 minuti senza alcun alimento all'interno.



**Si consiglia, per assicurarsi che l'apparecchio si trovi in condizioni di utilizzo e sicurezza perfette, di sottoporlo almeno una volta all'anno a manutenzione e controllo da parte di un centro di assistenza autorizzato.**

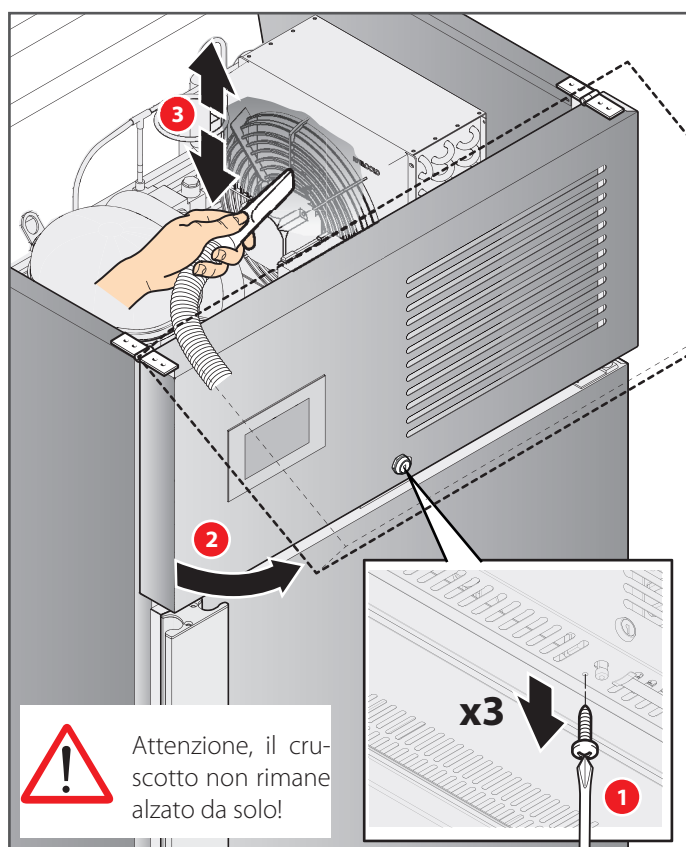
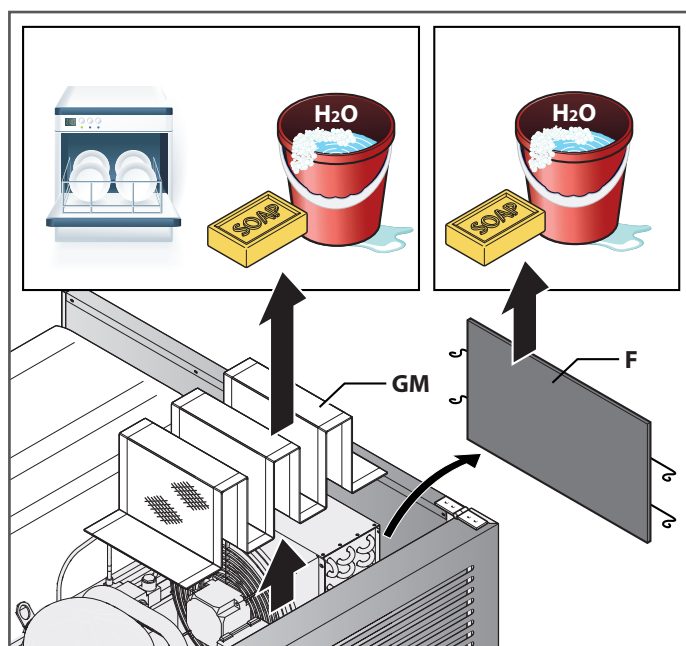
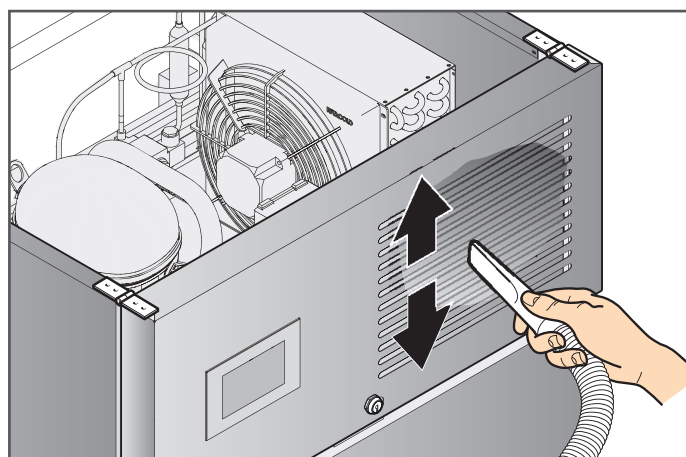

## Smaltimento a fine vita

Le operazioni di scollegamento dai circuiti elettrici ed idraulici devono essere effettuate esclusivamente da tecnici qualificati.

Se presenti recuperare e smaltire in modo corretto:

- gas refrigerante;
- soluzioni incongelandibili presenti nei circuiti idraulici, evitando versamenti o perdite in ambiente.

Ai sensi dell'art. 13 del Decreto Legislativo n. 49 del 2014 "Attuazione della Direttiva RAEE 2012/19/EU sui rifiuti di apparecchiature elettriche ed elettroniche"



Il marchio del cassonetto barrato con barra specifica che il prodotto è stata immesso sul mercato successivamente al 13 agosto 2015 e che alla fine della propria vita utile non deve venire assimilato agli altri rifiuti ma deve essere smaltito separatamente.

Tutte le apparecchiature sono realizzate con materiali metallici riciclabili (acciaio inox, ferro, alluminio, lamiera zincata, rame, ecc.) in percentuale superiore al 90% in peso.

Rendere inutilizzabile l'apparecchiatura per lo smaltimento rimuovendo il cavo di alimentazione e qualsiasi dispositivo di chiusura vani o cavità (ove presenti).

E' necessario porre attenzione alla gestione di questo prodotto nel suo fine vita riducendo gli impatti negativi sull'ambiente e migliorando l'efficacia d'uso delle risorse, applicando i principi di "chi inquina paga", prevenzione, preparazione per il riutilizzo, riciclaggio e recupero.

Si ricorda che lo smaltimento abusivo o non corretto del prodotto comporta l'applicazione delle sanzioni previste dalla corrente normativa di legge.

### Informazioni sullo smaltimento in Italia

In Italia le apparecchiature RAEE devono essere consegnate:

- ai Centri di Raccolta (chiamati anche isole ecologiche o piattaforme ecologiche)
- al rivenditore presso il quale si acquista una nuova apparecchiatura, che è tenuto a ritirarle gratuitamente (ritiro "uno contro uno");

### Informazioni sullo smaltimento in nazioni dell'unione europea

La Direttiva comunitaria sulle apparecchiature RAEE è stata recepita in modo diverso da ciascuna nazione, pertanto se si desidera smaltire questa apparecchiatura suggeriamo di contattare le autorità locali o il Rivenditore per chiedere il metodo corretto di smaltimento.



In attesa di smantellamento e smaltimento, l'apparecchiatura può essere provvisoriamente immagazzinata anche all'aperto, purché l'unità abbia i circuiti elettrici, frigoriferi e idraulici integri e chiusi. Accertarsi inoltre che le porte non possano essere chiuse per evitare intrappolamenti.

Vanno comunque osservate le leggi vigenti nel paese dell'utilizzatore in materia di tutela dell'ambiente.

## Malfunzionamenti

Se l'apparecchiatura non funziona o si notano alterazioni funzionali o strutturali:

- disconnetterla dall'alimentazione elettrica e idrica;
- consultare la tabella sottostante per verificare le soluzioni proposte;

Se la soluzione non fosse presente in tabella, contattare un centro di assistenza autorizzato dal costruttore, comunicando:

- la natura del difetto;
- il codice ed il numero di matricola dell'apparecchio che si possono rilevare dalla targhetta caratteristiche dello stesso.

Per la riparazione pretendere ricambi originali: il costruttore declina ogni responsabilità e non riconosce il diritto di garanzia per l'impiego di ricambi non originali.



Si consiglia, per assicurarsi che l'apparecchio si trovi in condizioni di utilizzo e sicurezza perfette, di sottoporlo almeno una volta all'anno a manutenzione e controllo da parte di un centro di assistenza autorizzato.

1		2		3		4		5		6		7		8		9		10		11		12		13		14		15		16		17	
MATRICOLA-SERIE NR.-SERIAL NO. - NO. OE SERIE - رقم التسلسلي		CODICE - KODE - CODE - RÉFÉRENCE PRODUIT - رمز		MODELLO		TENSIONE		CORRENTE ASSORBITA		POTENZA DELLA RESISTENZA		POTENZA DELLA RESISTENZA		POTENZA NOMINALE		POTENZA LAMPADA		POTENZA MINIMA		REFRIGERANTE		GAS ESPANDENTE		ANNO FABBRICAZIONE		CLASSE CLIMATICA		MARCHIO		MARCHIO		MARCHIO	

- |   |                                         |    |                                      |
|---|-----------------------------------------|----|--------------------------------------|
| 1 | Costruttore                             | 10 | Potenza nominale di altre resistenze |
| 2 | Matricola                               | 11 | Potenza lampada                      |
| 3 | Codice                                  | 12 | Pressione minima e massima           |
| 4 | Modello                                 | 13 | Refrigerante, tipo e quantità        |
| 5 | Tensione                                | 15 | Gas espandente nell'isolamento       |
| 6 | Corrente assorbita in funzionamento     | 16 | Anno fabbricazione                   |
| 8 | Potenza della resistenza di sbrinamento | 17 | Classe climatica (#)                 |
| 9 | Potenza della resistenza di sbrinamento |    |                                      |

Tipo di problema	Prima di contattare un centro di assistenza, verificare che...
L'apparecchiatura è completamente spenta.	- ...ci sia tensione elettrica all'impianto e che la spina non sia staccata.
L'apparecchiatura non raffredda abbastanza	- ...non ci sia influenza di una fonte di calore esterna; - ...le porte chiudano perfettamente; - ...il filtro del condensatore non sia intasato; - ...le griglie di aerazione frontali non siano ostruite da oggetti o polvere; - ...gli alimenti siano ben distribuiti all'interno della cella e non ostruiscano la ventilazione all'interno della cella; - ...l'apparecchiatura non sia sovraccarica di alimenti (rispettare le indicazioni di carico dell'apparecchiatura in proprio possesso).
L'apparecchiatura è molto rumorosa	- ...non ci siano contatti fra l'apparecchiatura e qualche altro oggetto o macchina; - ...l'apparecchiatura sia perfettamente livellata; - ...le viti visibili siano ben serrate.



Non tentare di riparare l'apparecchiatura da se, questo potrebbe causare danni anche gravi a persone, animali e cose e fa decadere la Garanzia. Richiedere sempre l'intervento di un centro di assistenza autorizzato dal costruttore e richiedere ricambi ORIGINALI.

ASSISTENZA POST VENDITA

## Garanzia

L'obbligo del costruttore per la garanzia sulle apparecchiature e sulle parti relative di sua produzione ha la durata di 1 anno, dalla data della fattura e consiste nella fornitura gratuita delle parti da sostituire che, a suo insindacabile giudizio, risultassero difettose.

Sarà premura del costruttore rimuovere eventuali vizi e difetti purché l'apparecchiatura sia stata installata e impiegata correttamente nel rispetto delle indicazioni riportate nel manuale. Sono esclusi dalla garanzia i danni derivabili da incrostazioni calcaree, sovratensione o manomissioni da parte di persone non autorizzate o non competenti.

I componenti di consumo come vetri, parti estetiche, guarnizioni, lampade e parti consumabili a seguito dell'utilizzo sono esclusi dalla garanzia.

Durante il periodo di garanzia saranno a carico del committente le spese concernenti le prestazioni d'opera, viaggi o trasferte, trasporto delle parti ed eventuali apparecchiature da sostituire.

I materiali sostituiti in garanzia restano di nostra proprietà e devono essere restituiti a cura e spese del committente.