

GUK-O 2/1-53

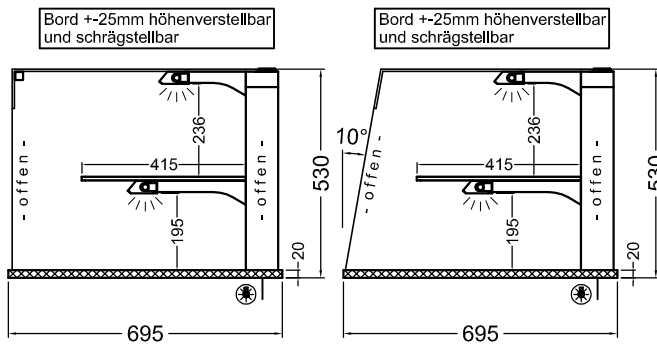

Variante GE

Variante GS